

Mikron

# MILL S

200 U



# Becoming better every day – since 1802

## GF Machining Solutions

When all you need is everything, it's good to know that there is one company that you can count on to deliver complete solutions and services. From unmatched Electrical Discharge Machining (EDM), Laser texturing, Laser micromachining, Additive Manufacturing and first-class Milling and Spindles to Tooling and Automation, all of our solutions are backed by unrivaled customer service and expert GF Machining Solutions training. Our AgieCharmilles, Microlution, Mikron Mill, Liechti, Step-Tec and System 3R technologies help you raise your game—and our digital business solutions for intelligent manufacturing, offering embedded expertise and optimized production processes across all industries, increase your competitive edge.



+ We are Mikron Mill.  
We are GF Machining Solutions.

# Contents

4	Applications
6	Highlights
8	Heidenhain TNC 640 control
9	smart machine
10	Table variants
12	Precision
14	Automation
16	High-tech HSC spindle
17	Tool magazine
18	Chip and dust management
20	Technical data
21	Options
22	GF Machining Solutions

The Mikron MILL S 200 U has been designed for the highest precision and surface quality.

These vertical high-speed machining centers are therefore offered for both tool and mold-making and the production of high-quality parts.

They incorporate the full technical competence of the Swiss machine manufacturer.

GF Machining Solutions

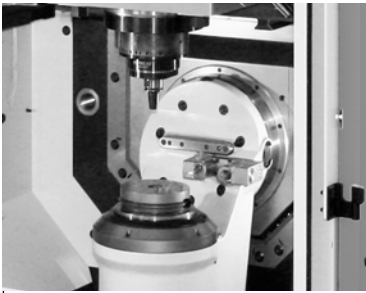

Mikron MILL S 200 U

# Applications

## Complex parts

- Various materials
- Watch-making industry / micro mechanics
- + Form and position accuracy
- + Extremely small geometries
- + Part-specific handling systems



## Electrodes

- Tungsten-copper / graphite
- Tool and mold-making
- + Surface quality
- + Dimensional accuracy
- + Very small geometric features

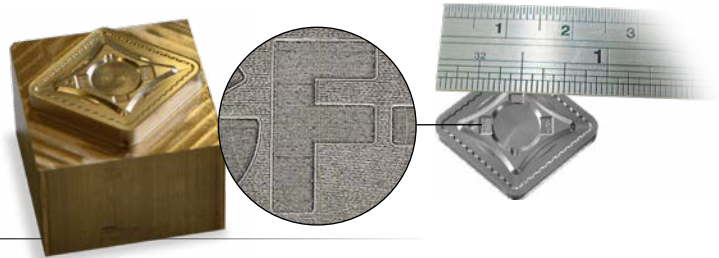

## Prostheses and implants

- Titanium / CoCr
- Medical technology
- + Powerful torque
- + 5-axis simultaneous machining
- + Perfect surfaces and working accuracy



## Fluidics

- Aluminum
- Automobile industry
- + 5-axis simultaneous machining
- + Shortest machining time
- + Excellent surface quality

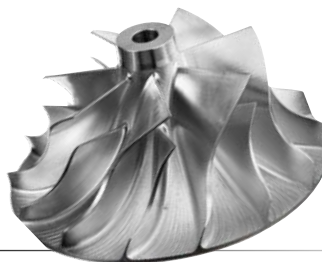

## Reflectors

- Powder-metallurgical tool steel
- Tool and mold-making
- + 5-axis machining
- + Specular surface quality

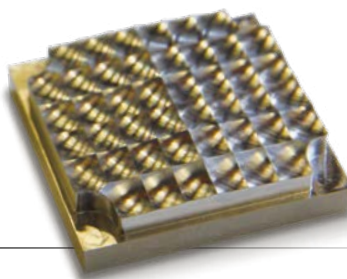

Perfect 5-axis machining  
without restriction.



Drive with ball screw

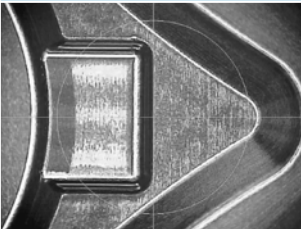

Drive with linear direct motor

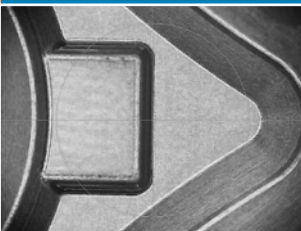



## Highlights

# Precision and quality for tool- and mold-making, as well as exact parts production

## Mikron MILL S 200 U



# For uncompromising demands. Dynamics and precision brought together in one unit.

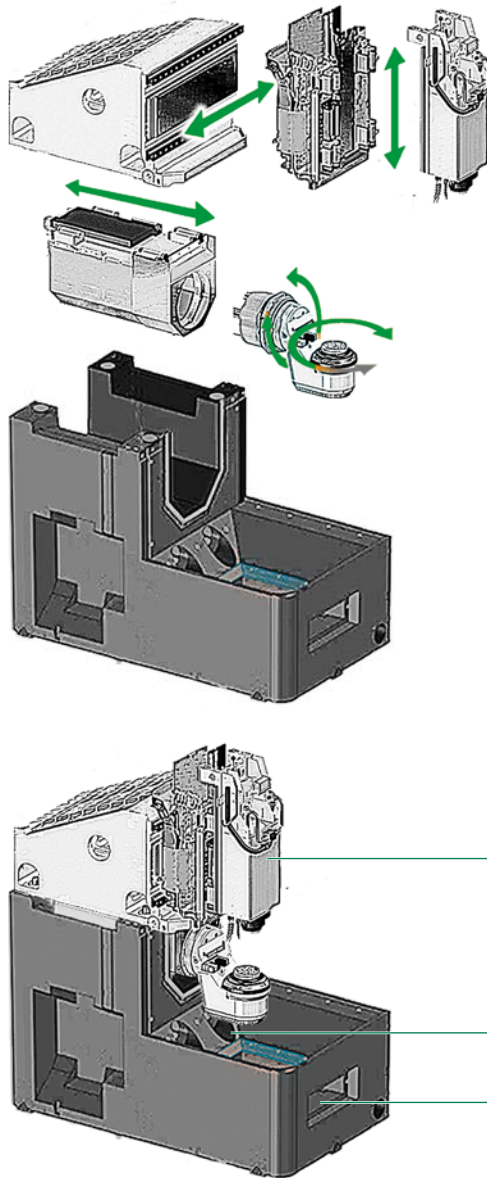

## Short power flow, short tolerance chain

With high-speed milling machines, most important prerequisites for very high precision and surface quality are damping and the stability of the machine structure. The revolutionary axis concept of the Mikron MILL S 200 U therefore consists of the following:

- + Polymer concrete machine base with strong damping properties and heavy static weight
- + Optimized force application and transmission within a slide construction
- + Linear axes with recirculating roller guides 35 mm wide (X, Y, and Z axes)
- + High dynamic rigidity of the linear direct drives
- + Water-cooled direct drives in all axes: X, Y, Z, B, C
- + Highly compact and extremely rigid axis assembly made of steel with thermal conductivity and expansion behavior
- + All guides above the machining area
- + Suction openings for graphite
- + Chip drawer

## Ergonomics

The spacious work area door enables the quick changing of externally equipped workpieces.

## Chip management

Machining chips fall into the central chip shaft below the machining table. With low chip volumes, chips are caught in a chip drawer. With high chip volumes, the chips are discharged via an external system together with the cooling lubricant.

## Dust management

Machining dust is sucked away centrally below the machining point. Two suction shafts integrated into the machine bed enable a generously proportioned suction cross section.

Heidenhain TNC 640 control

# Optimal machining efficiency is at your fingertip

The Heidenhain TNC 640 control provides flexibility and efficiency from job preparation until part is milled. Mounted on a pivot arm to give more operator's accessibility, the touchable screen allows the operator to quickly navigate through the control. Thanks to an user-friendly and practical interface in combination with several functionalities, the Heidenhain TNC 640 support operators in their daily job giving to them more availability for other tasks.



AMC (Automated Machine Calibration)

# Higher precision from the beginning

## AMC

Every MILL S 5 axis machine is featuring the new Automated Machine Calibration (AMC). This new calibration tool comes with the complete Calibration Hardware on a pallet and allows calibrating at any time the kinematic of the machine. Program it or release it manually simply by pressing the start button. Beside the machine kinematic, it will also automatically calibrate touch probe and tool measuring system when needed.

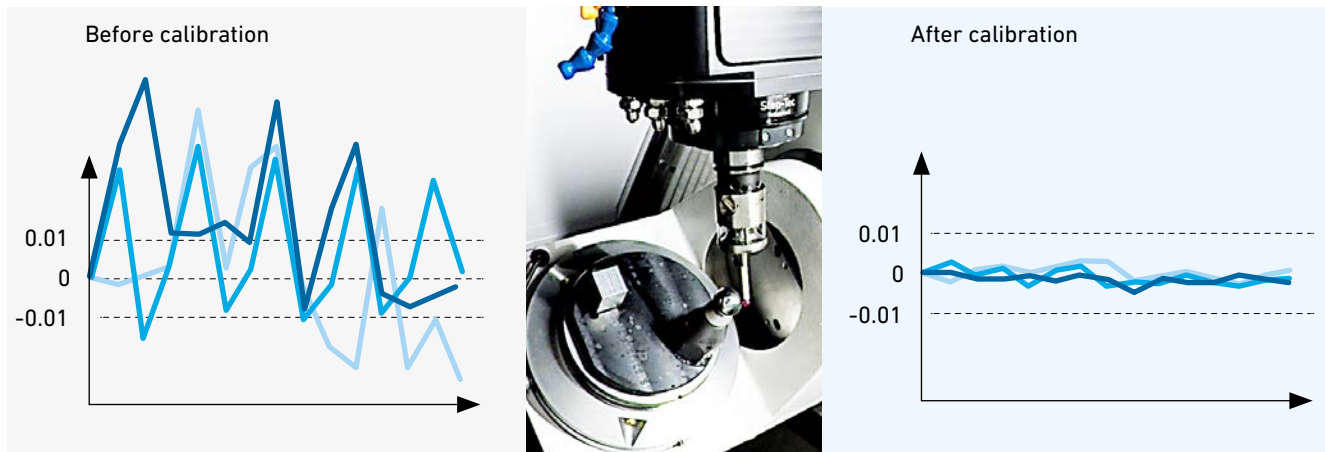



smart machine

# Enhance your process beyond program and machine setup

The smart machine functionalities gathers a range of modules that offers various features in order to make the Milling process "intelligent,"

Each of the modules fulfills a specific task. Just like in a construction kit, the user can select the modules that seem to him to be the best option for improving his process.

- Produce your workpieces in a process-secure and precise manner
- Increase reliability in unmanned operation
- Boost the service life of the machine
- Significantly reduce production costs

## Saving energy

smart machine modules like Econowatt, saving up to 50% energy, are ecological necessities with attractive economic advantages.

## Time

smart machine modules like OSS and software tools such as rConnect boost your productivity. OSS extreme yields up to 24 % more speed with improved surface finish and accuracy.



## Precision

smart machine modules like ITC and OSS support the precise base of your machining center to achieve an even more precise final part.

## Protection

smart machine modules like PFP protect and extend the lifetime of your machine and tools.

## smart machine classic package

Find your market and tune your machine accordingly

With the new smart machine package for 5 axis machines GF Machining Solutions combines some of the most powerful smart machine modules for your targeted applications and market needs. This tuning package will support you to get the best out of your machines according to your customer base.

For the 5 axis machines the included AMC extended corrects beside any position errors of the 4th and 5th axis also the angle errors of the swivel and rotary axis.

## Table variants

# As flexible as required

### Fully automatic production of small batches

Avoid unproductive periods during the production of small batches through

- + Automated changing of pallets or pallet-bound, part-specific zeropoint clamping systems
- + Automated changing of customer-specific individual parts through the employment of part-specific, zeropoint clamping systems

### A solution for all automation projects

Wide selection of simple or complex pallet designs

- + System 3R GPS 120
- + System 3R GPS 120 with up to 4 additional media on the pallet surface (can be activated via the M function and the pressure adjusted variably via the cycle, e.g. for System 3R TwistLock)

### Automatic zero-point clamping system for pallets



GPS 120

### Options for automatic zero-point clamping systems for customized parts



GPS 120 with 4x media



System 3R TwistLock



Watch plates

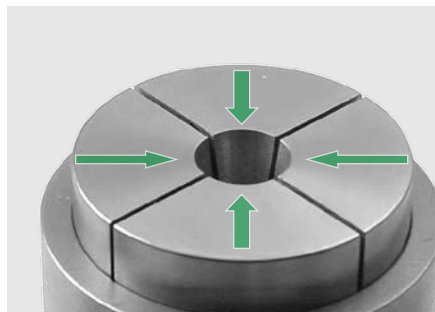

Automatically changeable collets

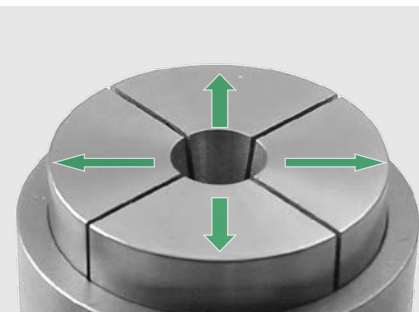

Automatically changeable expanding mandrel

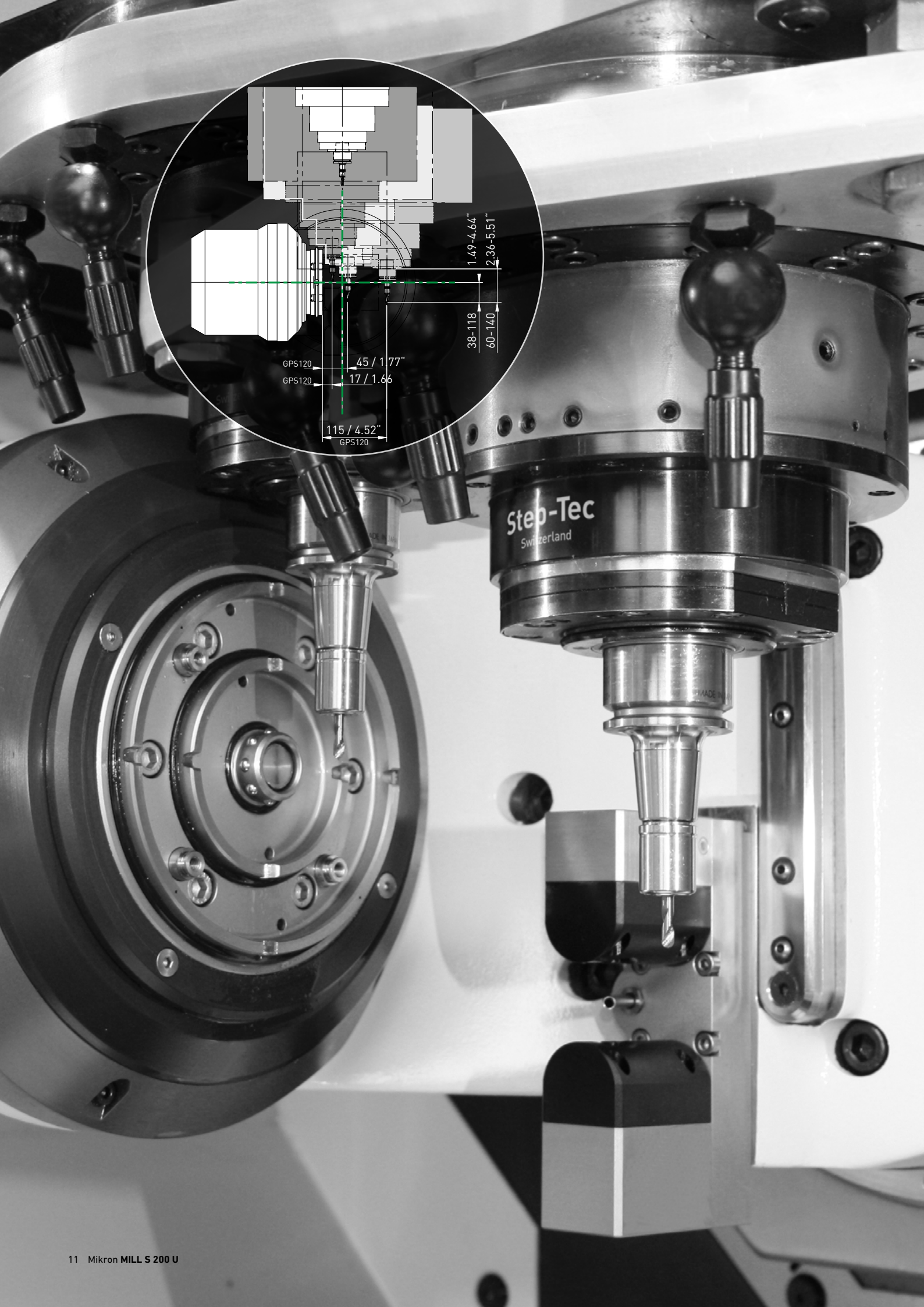



## Precision

# Core components: Static and dynamic precision

## Static precision

### Swiss thoroughness

Prior to delivery, each Mikron MILL S machine undergoes a comprehensive quality inspection in our air-conditioned assembly hall according to GF Machining Solutions acceptance guidelines.

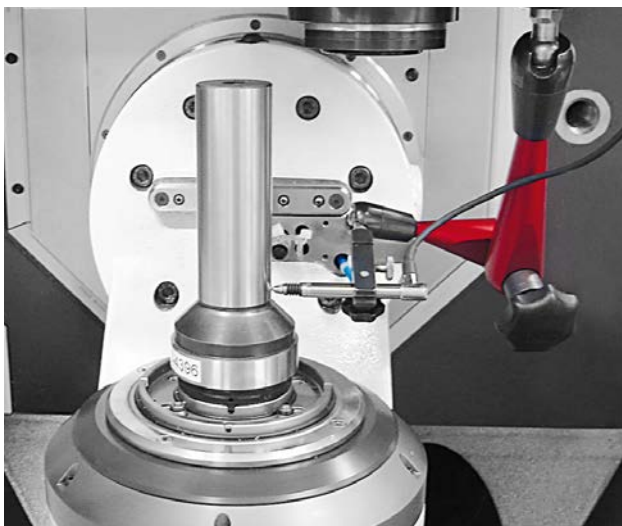
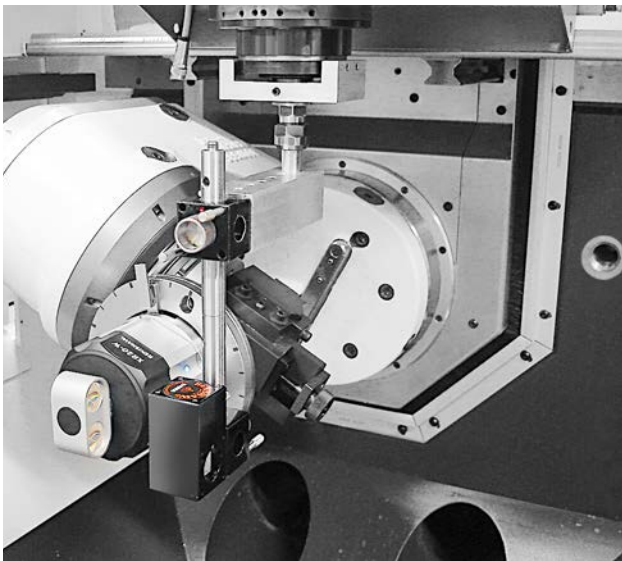

## Dynamic precision

### Position sensor systems

All Mikron MILL S 200 U machines are equipped with direct position sensor systems in the linear and rotary axes as standard.

- + Resolution in the nanometer range
- + Protected by sealing air

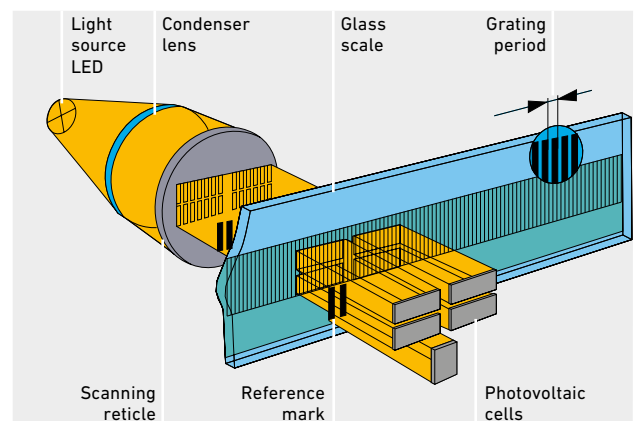
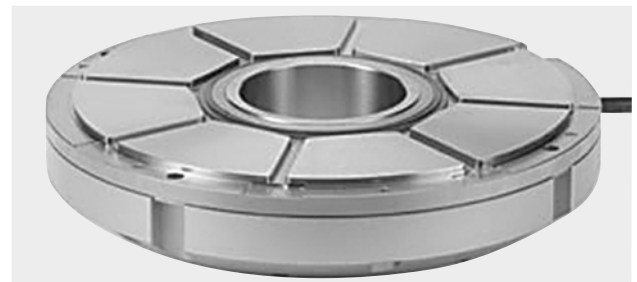

## Precision

# Core components: Thermal precision and component precision

### Thermal precision

#### Cooling concept and reserve capacity

The Mikron MILL S 200 U leads precision machining into a new era. Sophisticated cooling management for heat discharge of the electrical drive groups.

All linear axes and the circular-swivel unit feature a separate cooling circuit.



Five separate cooling circuits for the motors of the drives in the X, Y, Z, B/C axes, and the spindle motor.

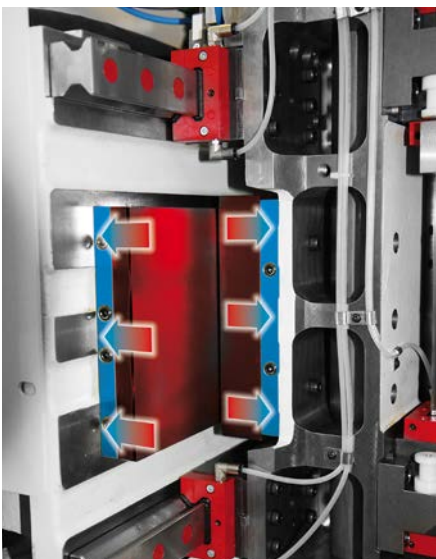

Primary and secondary part mounted on a large cooling plate.

### Component precision

#### Micro machining made easy

The workpiece and tool measuring systems are especially suited for micro machining.

- + Low tactile forces allow for damagefree and highly precise measurement of geometric features
- + Precision laser optics for highly precise measurement of very small tool diameters

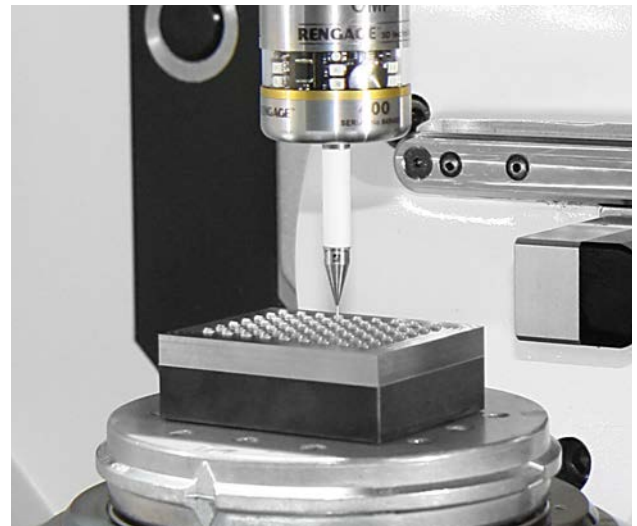

Low tactile forces and high temperature stability – 0.8 N of tactile force in the Z direction on thermo lock interface (hexagon / m&h)

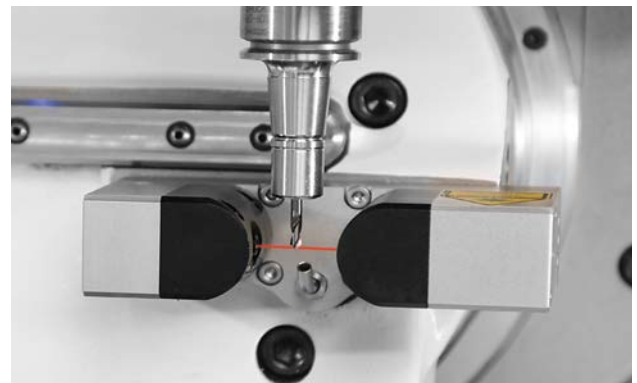

Precise measurement of very small tool diameters from 25 µm to 20 mm



## Automation

# More parts in less time at lower costs



With the Mikron MILL S 200 U, automatic production is ensured by the low-cost integration of the pallet magazine.

- + Repetitive machining is executed without interruption in multi-shift operation
- + The machine's efficiency is increased with an accordingly higher profit
- + System 3R GPS 120            14 pallets
- + System 3R MacroMagnum    12 pallets
- + System 3R Macro 70        20 pallets
- + System 3R Macro 54        20 pallets
- + Erowa ITS 148                12 pallets
- + Erowa ITS 115                14 pallets





**Increased  
profitability  
is indispensable  
today**





## High-tech HSC spindle

# Core components of Step-Tec

### Tool spindles for demanding machining

With a Mikron MILL S 200 U machine you get the latest tool spindle technology.

- + 50,000 rpm HSK E-32
- + High torque up to 20,000 rpm
- + Low spindle heating increases working accuracy
- + Highly stable double-ceramic hybrid bearings in an "O" configuration for very high radial capacity and rigidity during machining
- + Contact-free 3-chamber labyrinth seal for optimum sealing of the spindle nose
- + Vector control for full torque in the lower speed range
- + Oil/air lubrication system with extraction of the consumed oil
- + Very short acceleration time – 2 seconds from 0 to 50,000 rpm
- + Thread cutting without compensating chuck in steel up to M6 (CK45)

### smart machine

Supplied in the package is the APS (Advanced Processing System) smart machine module for the reliable recording and display of vibrations during the milling process.

### Step-Tec

Since 1995, Step-Tec has been developing, producing, selling, and repairing precise, high-performance spindles for leading manufacturers of machining centers for milling and drilling applications.

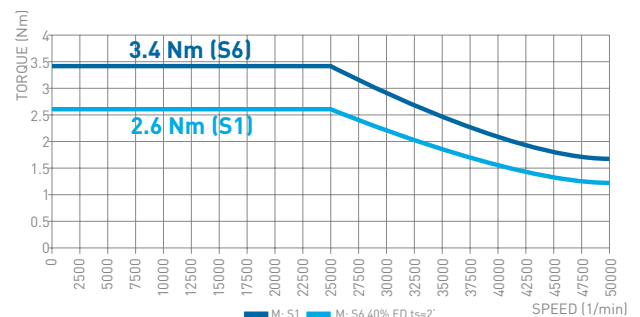
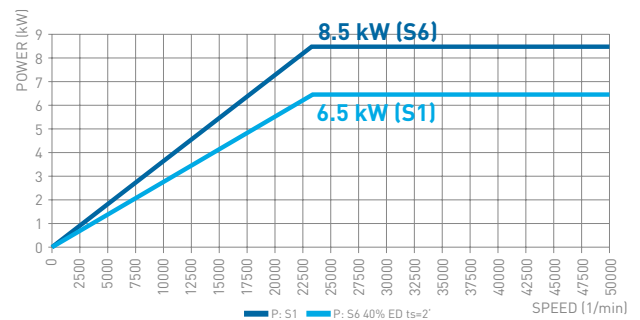

### Schematic diagram of three-chamber labyrinth

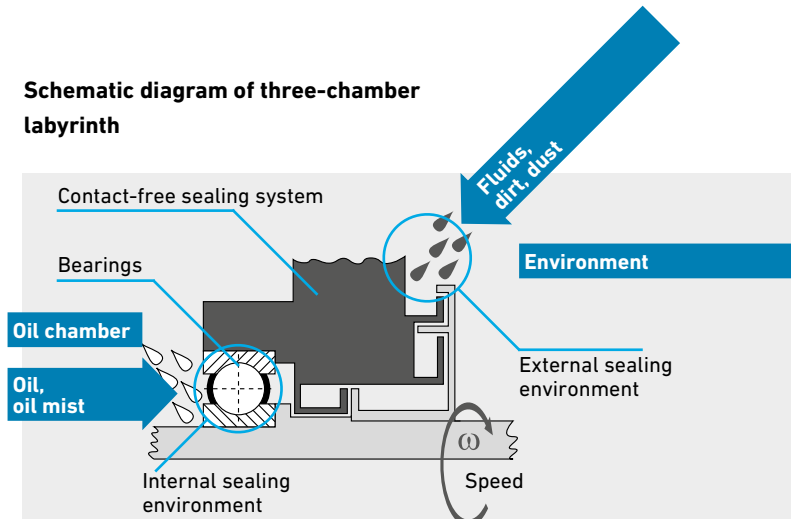

Tool magazine

# Tailored to your needs

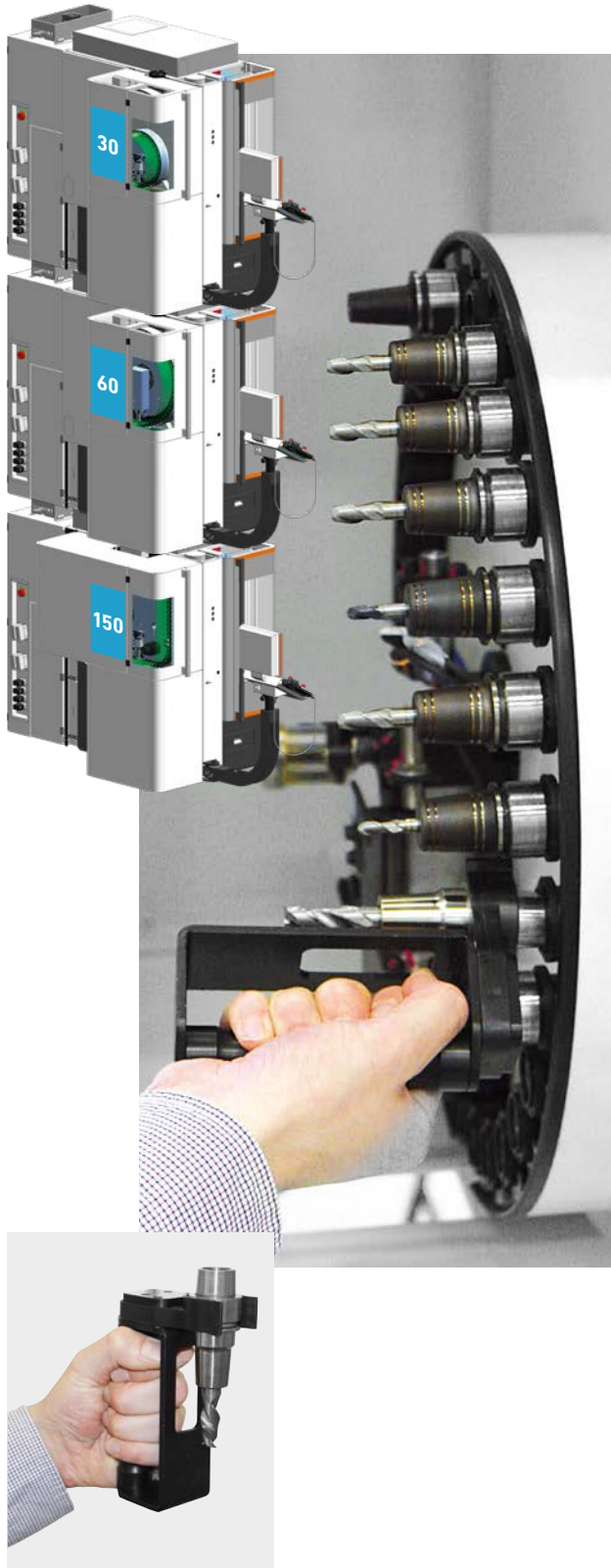

## Tool storage in many configurations

- + Disk magazine with 30, 60 or 150 tool positions
- + Reliable and extremely quick double-gripper change system
- + Chip-to-chip time in 4.4 seconds (TC 30 and 60)
- + Secure orientation of the measuring sensor through a firmly assigned magazine space

## Productivity and process safety

- + User-friendly tool feeding
- + Simple feed monitoring through a large glass panel
- + Secure access even during full automation
- + Feeding during machining possible

## Double-gripper change system

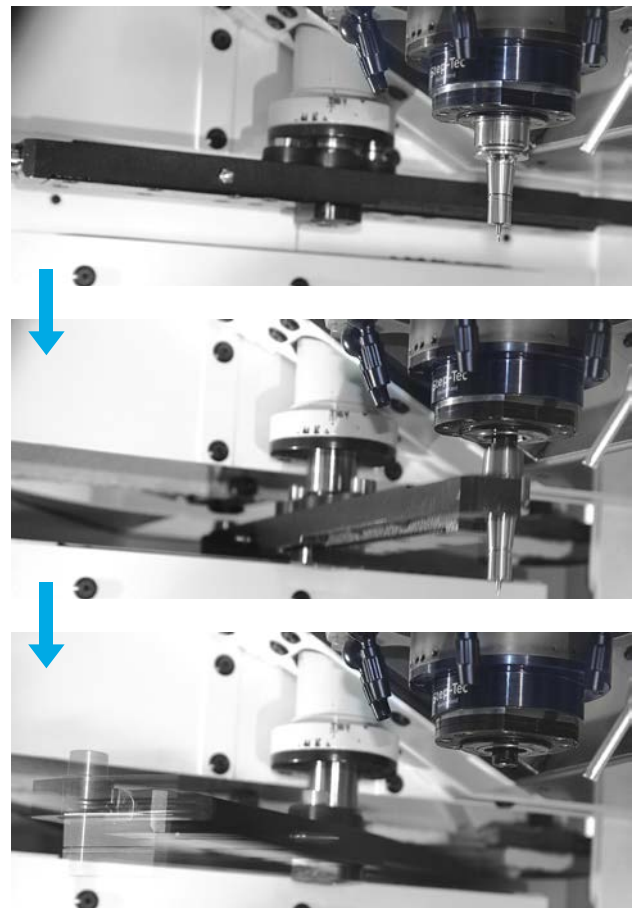

## Chip and dust management

# Clean work area

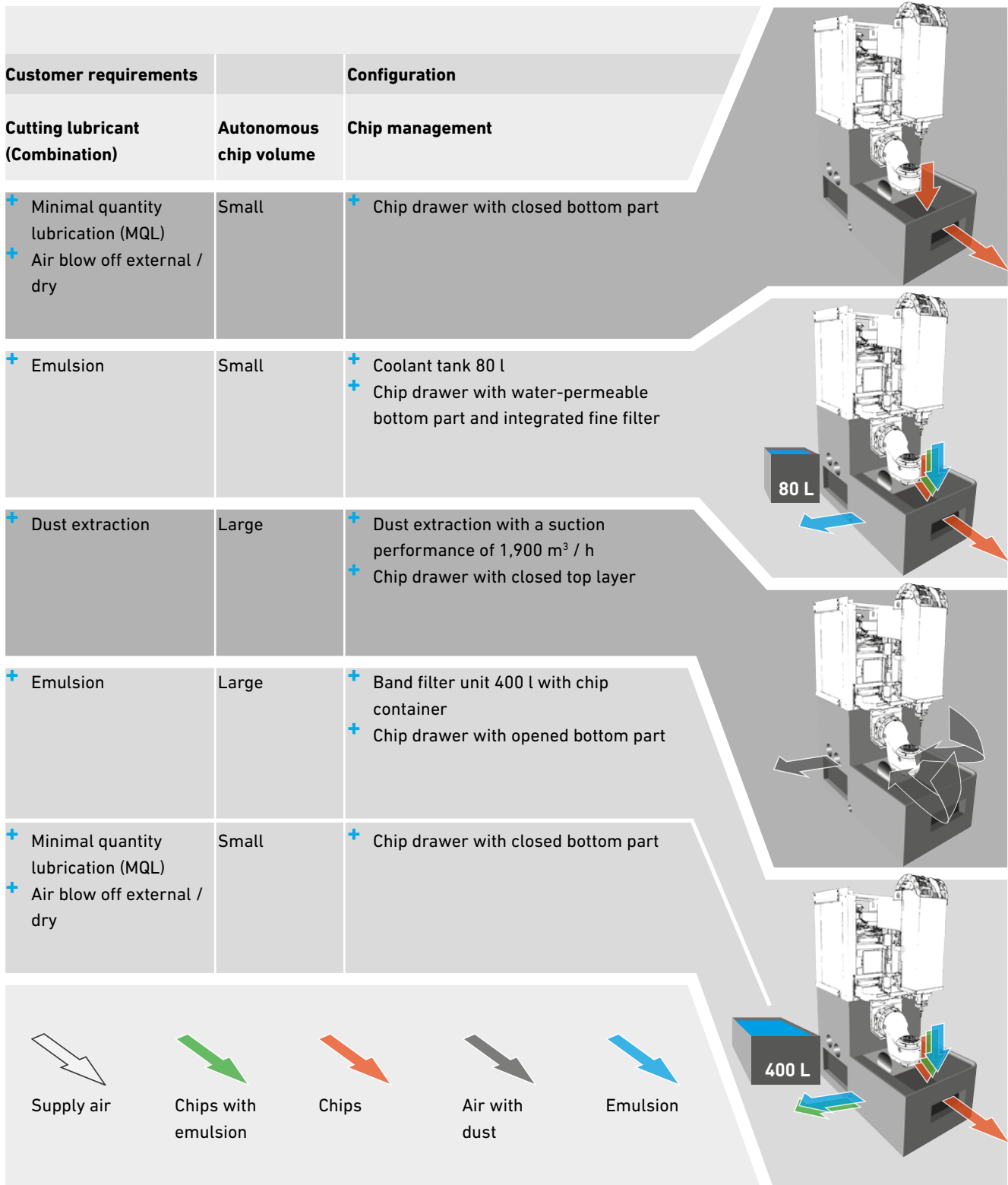



# Chips, graphite, emulsion. Always a solution!

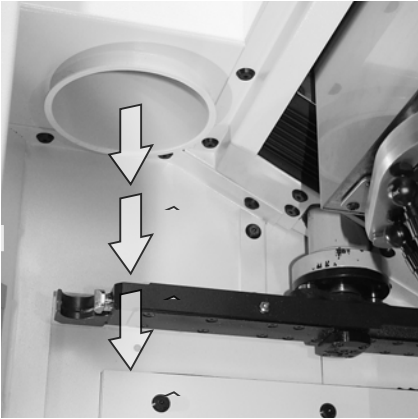

Supply air for dust extraction

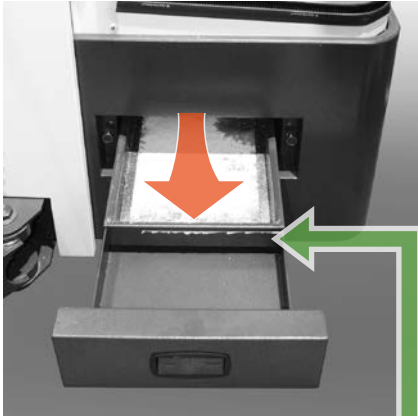

Chip drawer with water-permeable bottom part and integrated fine filter

Suction openings for dust

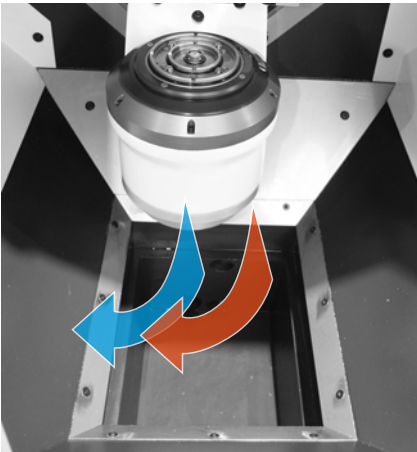
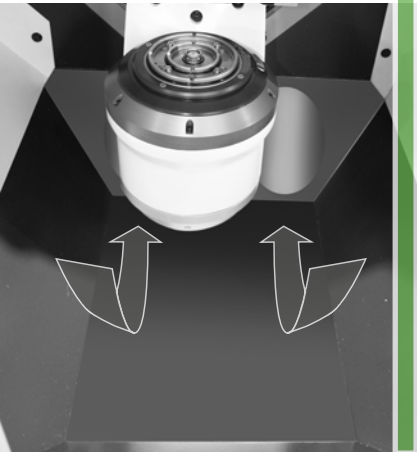

Drawer with opened bottom part for emulsion operation with large chip volume

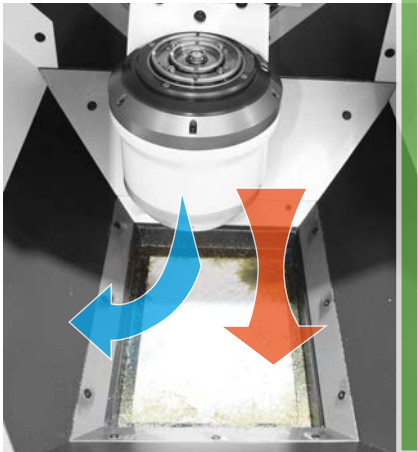

# Technical data

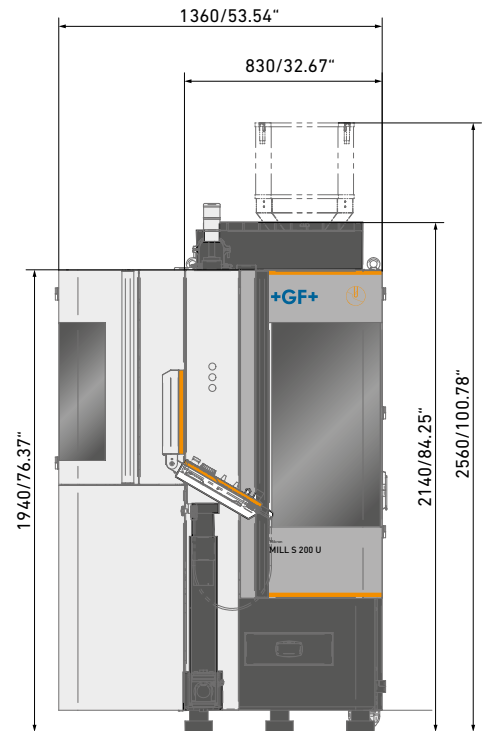

## MILL S 200 U

### Workarea

Longitudinal	X	mm	160
Cross	Y	mm	160
Vertical	Z	mm	200
B-axis		°	+30/-120
C-axis		°	n x 360
Number of simultaneous axis			5

### Feed drive

Feed rate	X, Y, Z	m / min	42
	B, C	min <sup>-1</sup>	150 / 220
Acceleration	X, Y, Z	m/sec <sup>2</sup>	up to 14
	B, C	rad/sec <sup>2</sup>	up to 165 / 418

### Accuracy (Standart)

Accuracy	A	μ	4
Repeatability	B	μ	2

### Work table

Clamping surface	mm	according Pal.
Max. table load	kg	8

### Tool magazine

Configuration	Positions	30, 60, 150
---------------	-----------	-------------

### Weight

Including Pallet magazine	approx. kg	3600
---------------------------	------------	------

### Options

Laser Tool Measuring		+
Coolant tank 80l / 400l		+
Mist extraction		+
Dust extraction		+

### Spindle

50'000 rpm	Power 40% ED	kW	8.5
HSK E32	Torque 40% ED	Nm	3.4

### Pallet magazine

GPS 120	Pallet	14
MacroMagnum, Macro 70, 54	Pallet	14, 20, 20
ITS 148, 115	Pallet	12, 14

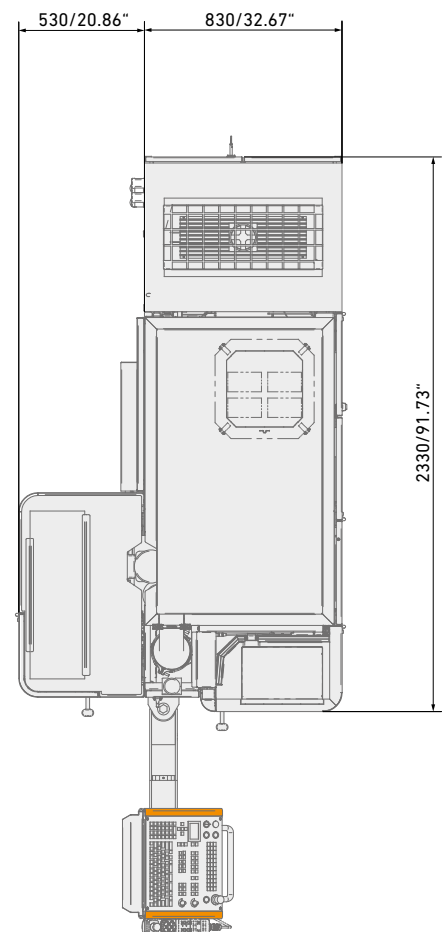

## Options

# Tailor-made equipment

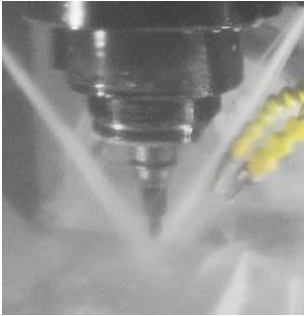

External coolant supply via two nozzles



Spray ring with up to nine individually adjustable nozzles



Coolant tank 80 l



Rotating window



Mist extraction



Dust extraction



Air blow on C-axis positioned over laser system



Air through spindle/spindle slots



Automation interface

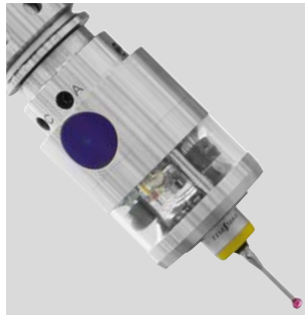

Touch probe m&h 40.40 LF/TI

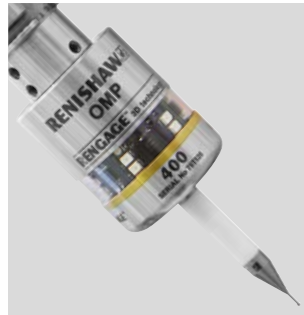

Touch probe Renishaw OMP400



Signal lamp



Heidenhain TNC640

## About GF Machining Solutions

# Multi-technology solutions provider

Our commitment to you and your specific applications is proven by the value-adding intelligence, productivity and quality delivered by our multi-technology solutions. Your success is our chief motivator. That's why we are continuously advancing our legendary technical expertise. Wherever you are, whatever your market segment and whatever the size of your operation, we have the complete solutions and the customer-centric commitment to accelerate your success—today.

### EDM (Electrical Discharge Machining)



#### Wire-cutting EDM

GF Machining Solutions' wire-cutting EDM is fast, precise and increasingly energy efficient. From ultraprecise machining of miniaturized components down to 0.02 mm to powerful solutions for demanding high-speed machining with respect to surface accuracy, our wire EDM solutions position you for success.

#### Die-sinking EDM

GF Machining Solutions is revolutionizing die-sinking EDM with features like iGAP technology to dramatically boost machining speed and reduce electrode wear. All of our die-sinking systems offer fast removal and deliver mirror finishes of Ra 0.1 µm (4 µin).

#### Hole-drilling EDM

GF Machining Solutions' robust hole-drilling EDM solutions enable you to drill holes in electrically conductive materials at a very high speed—and, with a five-axis configuration, at any angle on a workpiece with an inclined surface.

### Tooling and Automation



#### Tooling

Our customers experience complete autonomy while maintaining extreme accuracy, thanks to our highly accurate System 3R reference systems for holding and positioning electrodes and work pieces. All types of machines can easily be linked, which reduces set-up times and enables a seamless transfer of workpieces between different operations.

#### Automation

Together with System 3R, we also provide scalable and cost-effective Automation solutions for simple, single machine cells or complex, multi-process cells, tailored to your needs.

### Milling



#### Milling

Precision tool and mold manufacturers enjoy a competitive edge with our Mikron MILL S solutions' fast and precise machining. The Mikron MILL P machines achieve above-average productivity thanks to their high performance and Automation. Customers seeking fastest return on investment benefit from the affordable efficiency of our MILL E solutions.

#### High Performance Airfoil Machining

Our Liechti turnkey solutions enable the highly dynamic manufacturing of precision airfoils. Thanks to the unique performance and our expertise in airfoil machining, you increase productivity by producing at the lowest cost per part.

#### Spindles

As part of GF Machining Solutions, Step-Tec is engaged in the very first stage of each machining center development project. Compact design combined with excellent thermal and geometric repeatability ensure the perfect integration of this core component into the machine tool.

### Software



#### Digitalization solutions

To drive its digital transformation, GF Machining Solutions acquired symmedia GmbH, a company specialized in software for machine connectivity. Together, we offer a complete range of Industry 4.0 solutions across all industries. The future requires the ability to adapt quickly to continual digital processes. Our intelligent manufacturing offers embedded expertise, optimized production processes, and workshop Automation: solutions for smart and connected machines.

### Advanced manufacturing



#### Laser texturing

Aesthetic and functional texturing is easy and infinitely repeatable with our digitized Laser technology. Even complex 3D geometries, including precision parts, are textured, engraved, microstructured, marked and labeled.

#### Laser micromachining

GF Machining Solutions offers the industry's most complete line of Laser micromachining platforms optimized for small, high-precision features to meet the increasing need for smaller, smarter parts to support today's leading-edge products.

#### Laser Additive Manufacturing (AM)

GF Machining Solutions and 3D Systems, a leading global provider of additive manufacturing solutions and the pioneer of 3D printing, have partnered to introduce new metal 3D printing solutions that enable manufacturers to produce complex metal parts more efficiently.

### Service + Success



#### We take you to new heights

Our Success Packs are designed to maximise your return on investment and empower you in your quest for success across all industrial segments. Our subscription packs feature a comprehensive range of services that guarantee the access and support you need to get the most out of your assets today, while preparing for the challenges of tomorrow. Our trusted experts backed by our latest cutting-edge, intelligent Digital Solutions, provide a full range of services.



## Switzerland

---

Biel/Bienne  
Losone  
Geneva  
Flawil  
Langnau

[www.gfms.com](http://www.gfms.com)  
[www.gfms.com/ch](http://www.gfms.com/ch)

## Europe

---

Germany, Schorndorf  
[www.gfms.com/de](http://www.gfms.com/de)

United Kingdom, Coventry  
[www.gfms.com/uk](http://www.gfms.com/uk)

Italy, Agrate Brianza - MI  
[www.gfms.com/it](http://www.gfms.com/it)

Spain, Sant Boi de Llobregat  
Barcelona  
[www.gfms.com/es](http://www.gfms.com/es)

France, Palaiseau  
[www.gfms.com/fr](http://www.gfms.com/fr)

Poland, Raszyn / Warsaw  
[www.gfms.com/pl](http://www.gfms.com/pl)

Czech Republic, Brno  
[www.gfms.com/cz](http://www.gfms.com/cz)

Sweden, Vällingby  
[www.gfms.com/system3r](http://www.gfms.com/system3r)

Turkey, Istanbul  
[www.gfms.com/tr](http://www.gfms.com/tr)

## Americas

---

USA  
Lincolnshire, IL  
Chicago, IL  
Holliston, MA  
Huntersville, NC  
Irvine, CA  
Woodridge, IL  
[www.gfms.com/us](http://www.gfms.com/us)

Canada, Mississauga ON  
[www.gfms.com/us](http://www.gfms.com/us)

Mexico, Monterrey NL  
[www.gfms.com/us](http://www.gfms.com/us)

Brazil, São Paulo  
[www.gfms.com/br](http://www.gfms.com/br)

## Asia

---

China  
Beijing, Shanghai,  
Chengdu, Dongguan,  
Hong Kong, Changzhou  
[www.gfms.com/cn](http://www.gfms.com/cn)

India, Bangalore  
[www.gfms.com/sg](http://www.gfms.com/sg)

Japan  
Tokyo, Yokohama  
[www.gfms.com/jp](http://www.gfms.com/jp)

Korea, Seoul  
[www.gfms.com/kr](http://www.gfms.com/kr)

Malaysia, Petaling Jaya  
[www.gfms.com/sg](http://www.gfms.com/sg)

Singapore, Singapore  
[www.gfms.com/sg](http://www.gfms.com/sg)

Taiwan  
Taipei, Taichung  
[www.gfms.com/tw](http://www.gfms.com/tw)

Vietnam, Hanoi  
[www.gfms.com/sg](http://www.gfms.com/sg)



## At a glance

We enable our customers to run their businesses efficiently and effectively by offering innovative Milling, EDM, Laser, Additive Manufacturing, Spindle, Tooling and Automation solutions. A comprehensive package of services completes our proposition.

[www.gfms.com](http://www.gfms.com)



© GF Machining Solutions Management SA, 2022  
The technical data and illustrations are not binding.  
They are not warranted characteristics and are  
subject to change.