

AgieCharmilles

CUT F

350/600

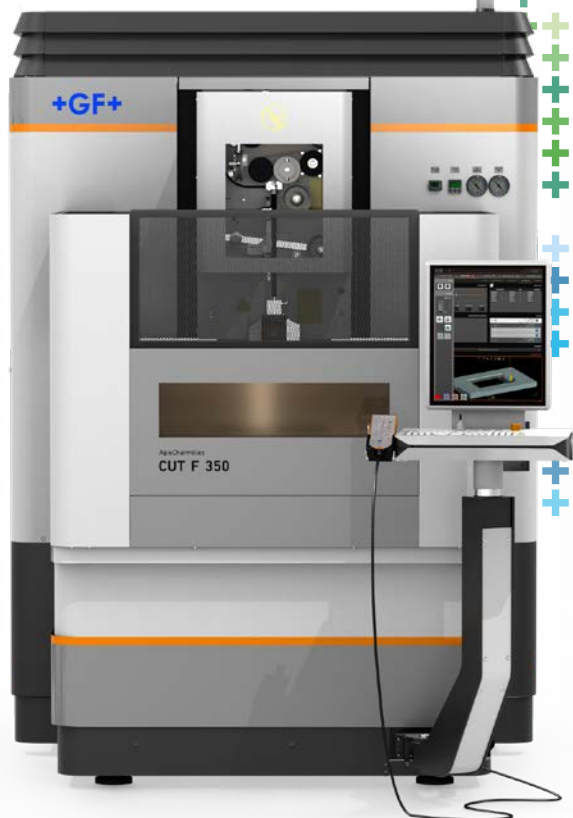

Becoming better every day – since 1802

GF Machining Solutions

When all you need is everything, it's good to know that there is one company that you can count on to deliver complete solutions and services. From unmatched Electrical Discharge Machining (EDM), Laser texturing, Laser micromachining, Additive Manufacturing and first-class Milling and Spindles to Tooling and Automation, all of our solutions are backed by unrivaled customer service and expert GF Machining Solutions training. Our AgieCharmilles, Microlution, Mikron Mill, Liechti, Step-Tec and System 3R technologies help you raise your game—and our digital business solutions for intelligent manufacturing, offering embedded expertise and optimized production processes across all industries, increase your competitive edge.



+ We are AgieCharmilles.
We are GF Machining Solutions.

Contents

4	Optimized for flexibility
6	Stable accuracy
8	UNIQUA
14	IPG: Intelligent Power Generator
16	Spark Track
17	ISPS: Intelligent Spark Protection System
17	iWire
18	Dedicated technologies
19	Turbo Tech
19	Certified wires
20	TAPER-EXPERT
21	ASW: Automatic Slug Welding
22	Medical instruments
23	Aerospace structures
24	Technical specifications
26	About GF Machining Solutions

CUT F series

Optimized for flexibility

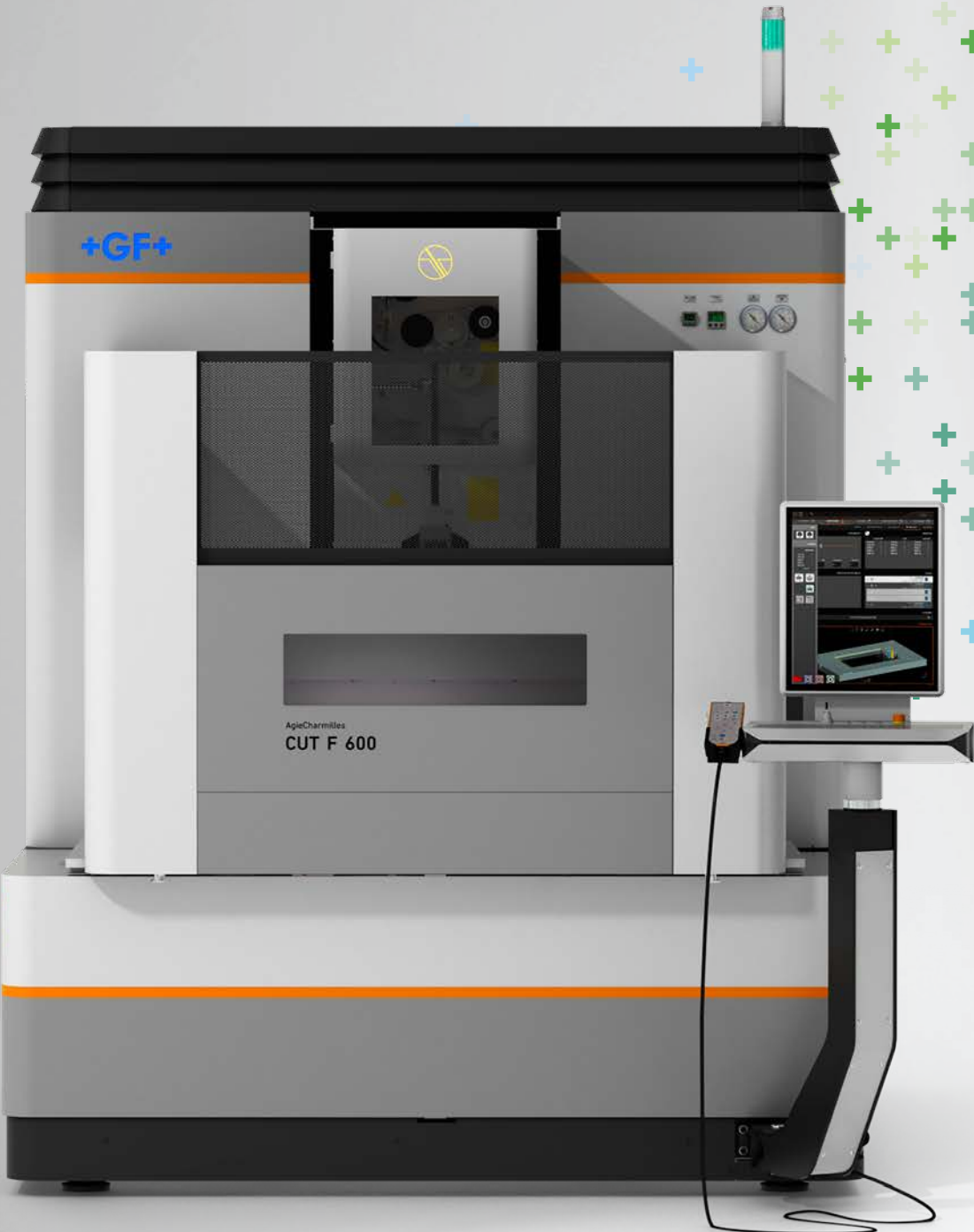



More with less

Reduce energy, consumables and operator intervention thanks to the CUT F. Every feature is made to save your costs: IPG (Intelligent Power Generator), iWire which reduces wire consumption as well as ISPS (Intelligent Spark Protection System).

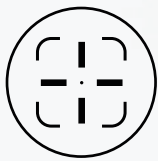

Stable accuracy

Higher accuracy of the ball screw and the embedded thermostabilization of key components are major features that help you achieve stability and precision in every machining job. Improved positional accuracy is brought by mechanical design optimization and higher quality grade components.



Flexible process

The UNIQUA HMI allows sequential programming as well as object-oriented programming, giving you more flexibility. Whether you are an experienced user or a beginner, the CUT F allows you to quickly become familiar with job programming.

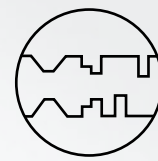

Spark Track

If you need to machine parts with variable heights, the CUT F enables you to adapt to high or low cutting parameters, preventing mechanical constraints and optimizing the process. Spark Track automatically adjusts spark energy in real time to prevent wire breakage and maintain optimal cutting speed.



AgieCharmilles
CUT F 350

CUT F series

Stable accuracy

Optical encoders improvement

Temperature fluctuations cause metal to expand or contract, resulting in changes to the dimensions of the machine components. By thermally stabilizing machine components, the effects of temperature fluctuations are minimized, ensuring consistent and accurate machining.

Reduce downtime

Machine components that are not thermally stabilized can experience significant variations in dimensions as temperatures change, leading to reduced accuracy and potential damage to the machine. By stabilizing the machine components, downtimes due to thermal issues are avoided.

Improved machining accuracy

Thermal stabilization improves machining accuracy. With consistent and stable machine components, the machine can produce parts with greater precision and consistency, reducing scrap and improving overall quality.

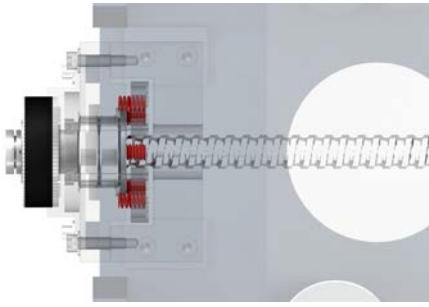

Integrated collision protection

Your operator can work with greater confidence during job preparation and execution, because the integrated collision protection on the X, Y and Z axes protects sensitive workpieces from damage.

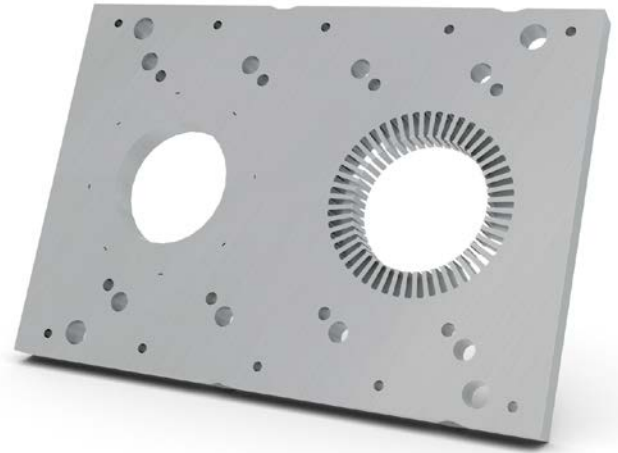

Automotive stamping tooling

Achieve amazing manufacturing results thanks to the high quality components of the CUT F and its optimized mechanical design. Benefit from high reliability and threading repeatability. Obtain the best pitch accuracy on the whole working area of a machined part with an average deviation under $\pm 2.5 \mu\text{m}$.

Higher ball screw precision grade

Achieve tighter tolerances, as well as more accurate positioning and movement. Produce parts with greater accuracy and consistency, reducing scrap and improving quality.

Increased repeatability

With a higher precision grade ball screw, accurately reproduce the same motion over and over again. This is particularly important for applications with mass production.

Improved durability

A higher precision grade ball screw is manufactured to tighter tolerances, resulting in a more robust and durable product. The ball screw will be able to withstand higher loads and perform reliably for a longer period of time, reducing maintenance costs.

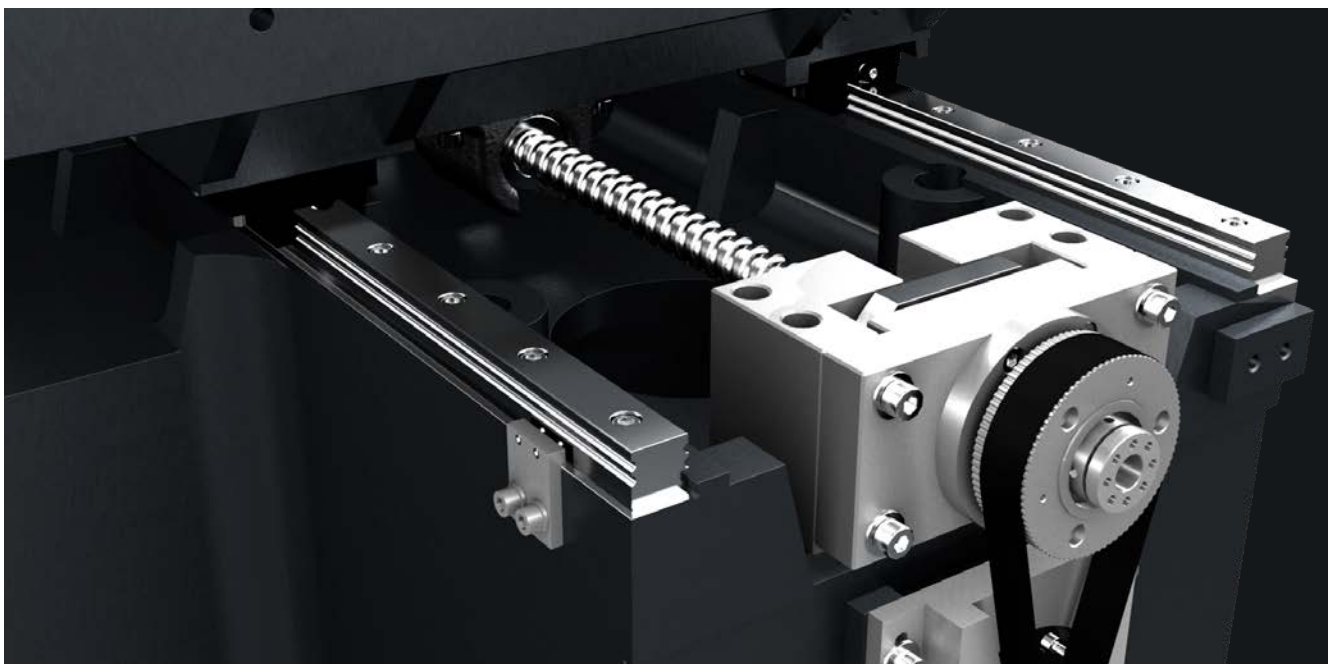

The human interface

UNIQUA

UNIQUA is the new GF Machining Solutions human/machine interface (HMI) for wire EDM machines. It represents the pinnacle of more than a century of EDM technology – and the perfect combination of optimal functionality and usability (ergonomics) from our previous HMIs.

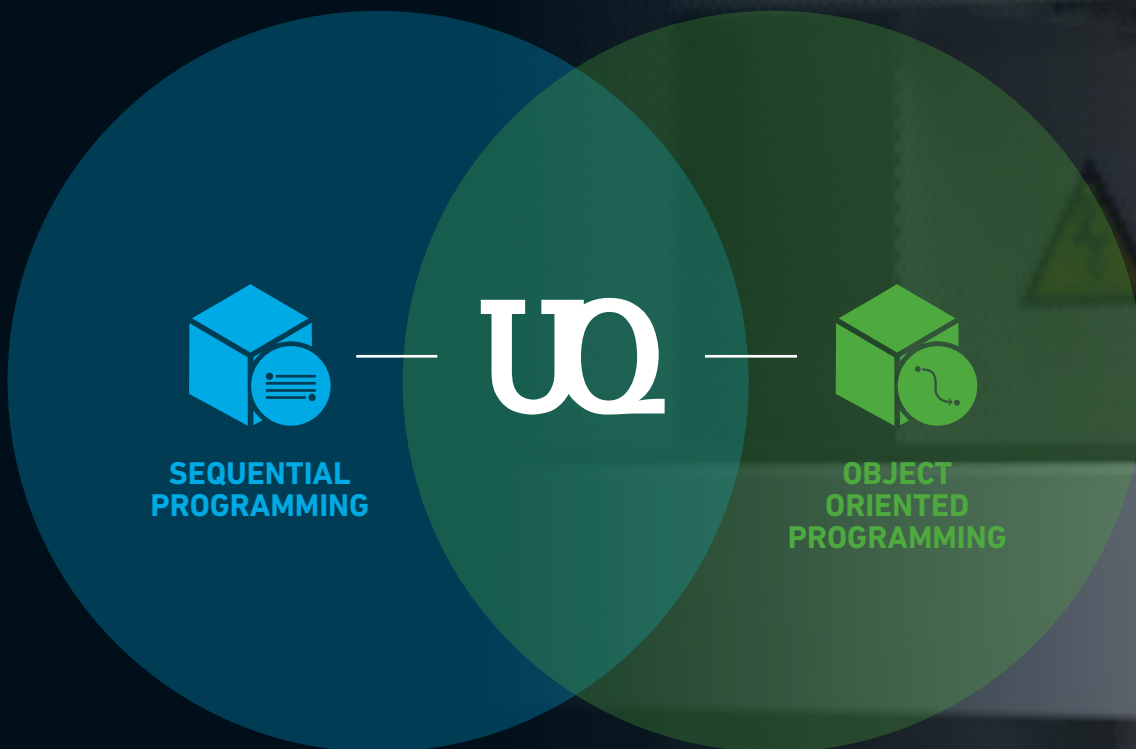

Every skill level

UNIQUA is ideal for wire EDM experts and beginners alike. While experts use its powerful functionalities, beginners can take advantage of its ease-of-use and short learning curve.

Every approach

UNIQUA works the way you want to work. Control the details of sequential programming with an updated ISO-based functionality or leverage the flexibility of object-oriented programming.

Every user

Work offline or at the machine. UNIQUA ensures compatibility with major CAD/CAM programs and also provides a powerful graphic tool with integrated CAM.



+GF+



UNIQUA

Easy to use

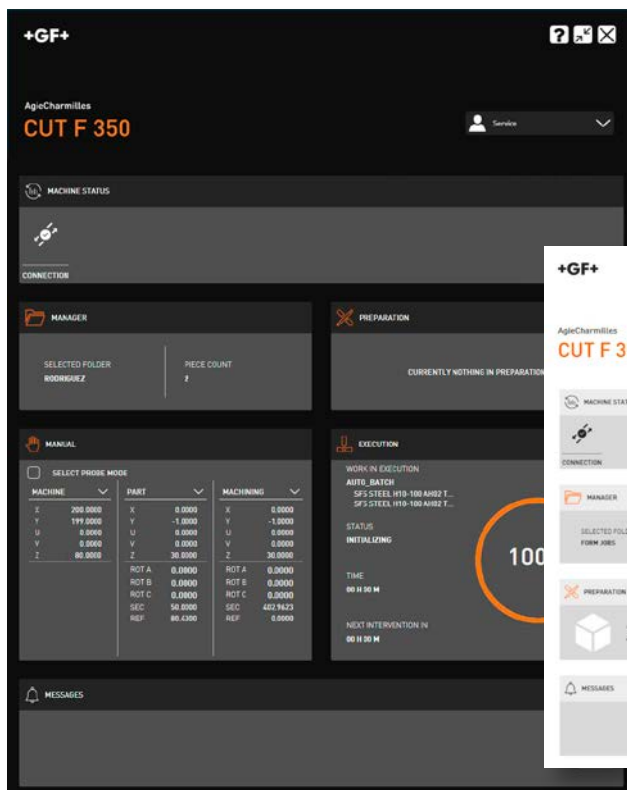

Interface innovation

Enter a new dimension of human-machine interface convenience. The new display panel provides operators with an intuitive, user-friendly 19" touchscreen. When connected to a computer, the panel can be displayed in portrait or landscape mode.

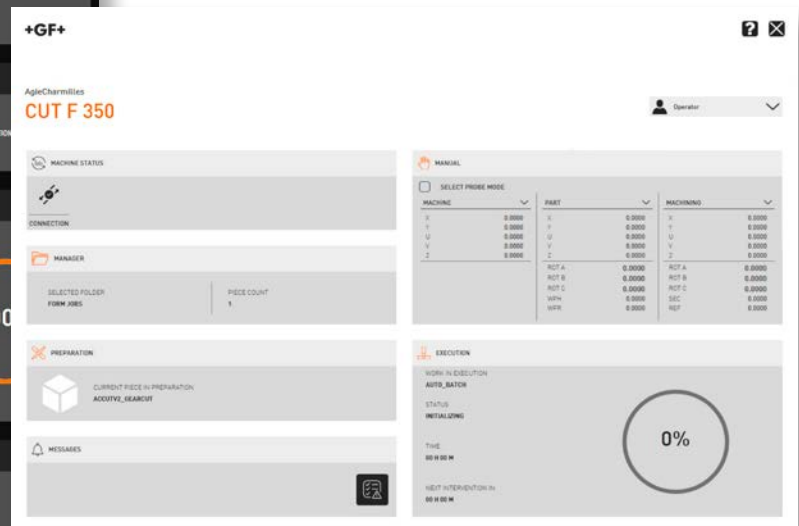

Dashboard power

Customizable dashboard widgets and easy-to-use menu system seamlessly guides you through the workflow process.

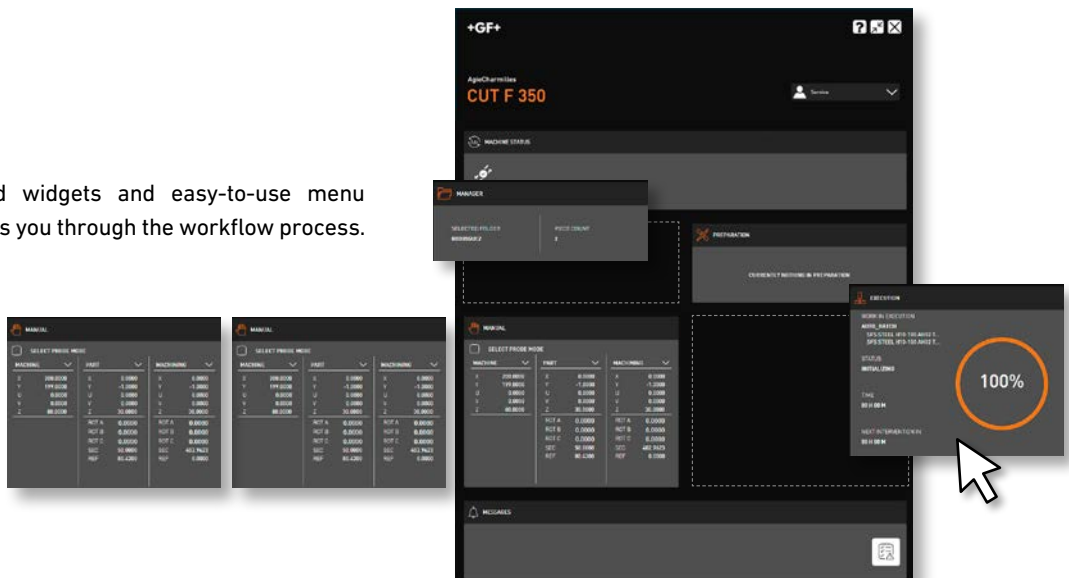

Intuitive interactivity

Shorten the learning curve and make any job easy with powerful graphic previews and an interactive help menu.

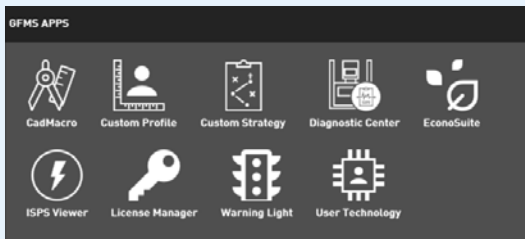
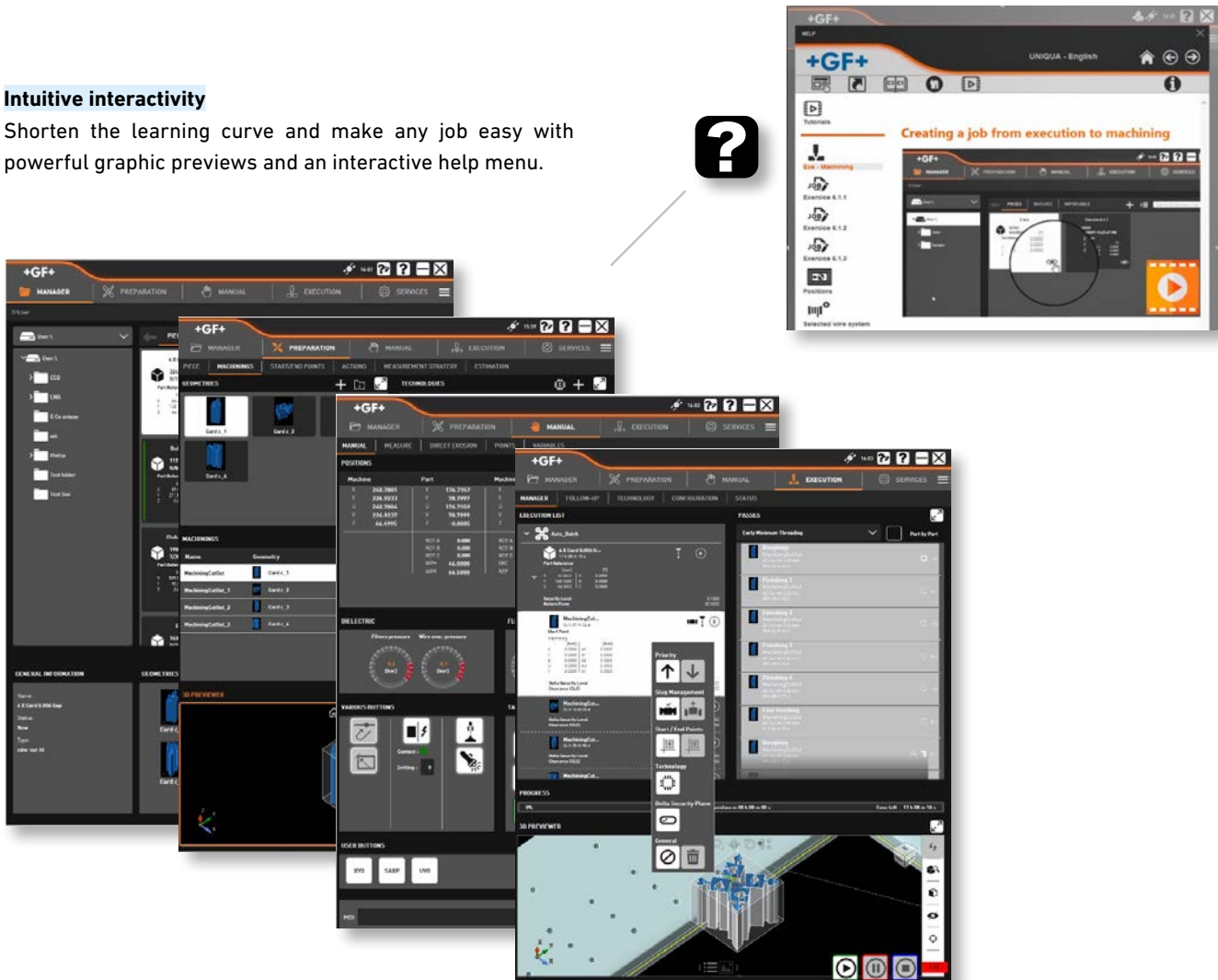

Work Space

UNIQUA tools are displayed as icons to allow for all users to easily identify key functions. GFMS applications such as Custom Profile, Custom Strategy, ISPS Viewer and User Technology, and many more, are available in two sections: Tool Box and External APPS.

Where flexibility meets productivity

Flexible data input

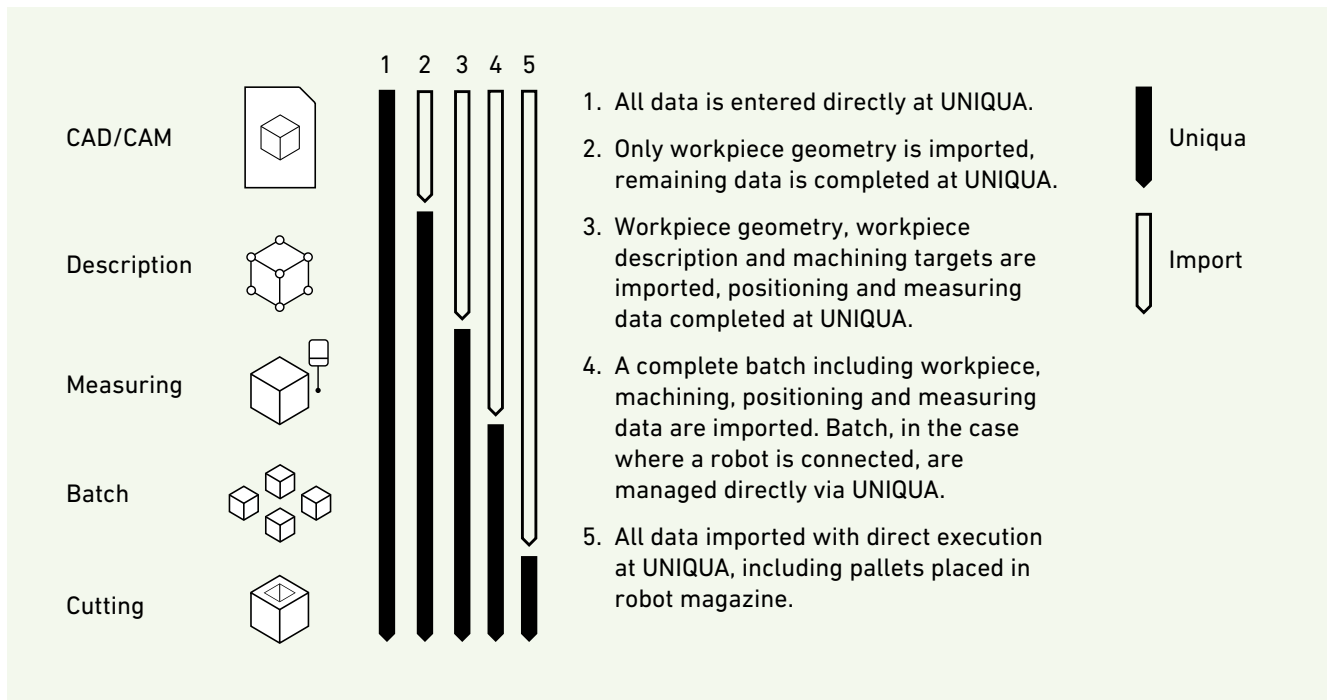

Workflow preparation

MANAGER: Manage folders, files and jobs to streamline preparation and execution.

PREPARATION: Import or create geometries, and define machining conditions, technology and sequences. 3D renderings of every job can be previewed and sent directly to execution or back to Management.

EXECUTION: The execution cockpit allows operators to configure and monitor the job with access to variables and points. The current job's operation can also be monitored graphically throughout the entire execution process.

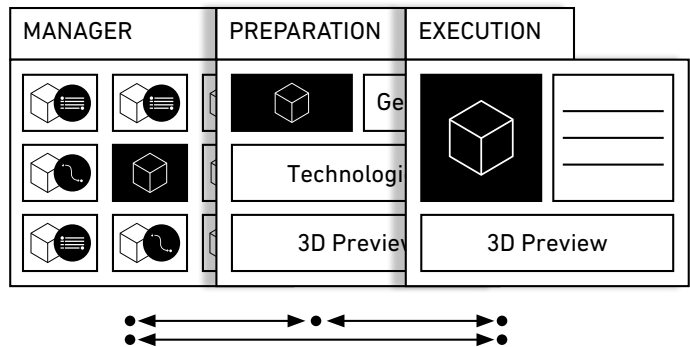

Change your working strategy at any time

UNIQUA's exclusive functionality offers you the flexibility to adjust cutting strategies anytime during preparation or execution.

Customized Strategy / Priorities

Customized machining sequences minimize unnecessary operator interventions and allow for planned downtime. Priorities can be changed during execution with "one click" directly at UNIQUA without interrupting machining.

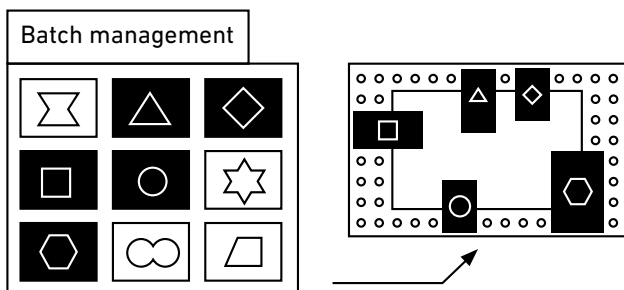
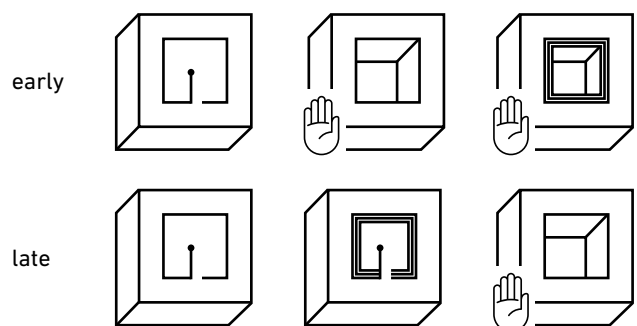

Optimized automation management

UNIQUA effectively manages workpieces by the piece, by the batch or on complete pallets. UNIQUA continuously monitors measuring and cutting processes to produce multiple pallets, which can be stored in the robot magazine. A full sequence of production in different pallets can be programmed directly from your CAD/CAM, avoiding the need of re-managing at the machine HMI.

Dynamic adaptation of batch execution

UNIQUA gives the operator full power to change workpiece and batch-execution priorities, including functions such as piece insert and priority change.

Piece insert

No loss of data or need of reprogramming when interrupting and inserting a job with Piece insert. The interrupted job is resumed exactly where it was stopped, without the need to modify existing data.

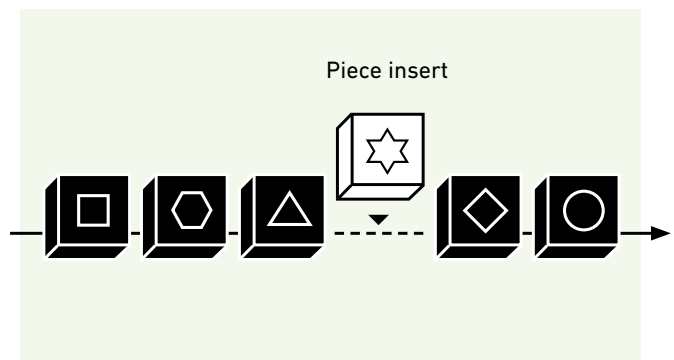



The digital brain

IPG: Intelligent Power Generator

The Intelligent Power Generator (IPG) with Direct Power Supply (DPS) module accommodates a very large range of machining systems, permitting a very high degree of precision associated with perfect surface quality and high speed. This digital generator controls the energy of each spark with great precision, providing a very fine surface quality down Ra 0.15 μm (6 μin).

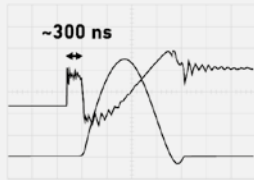
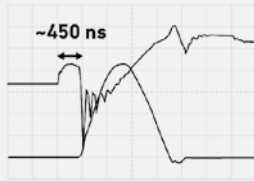

Current and voltage diagram of the sparking process showing the higher reactivity of the IPG-DPS generator.

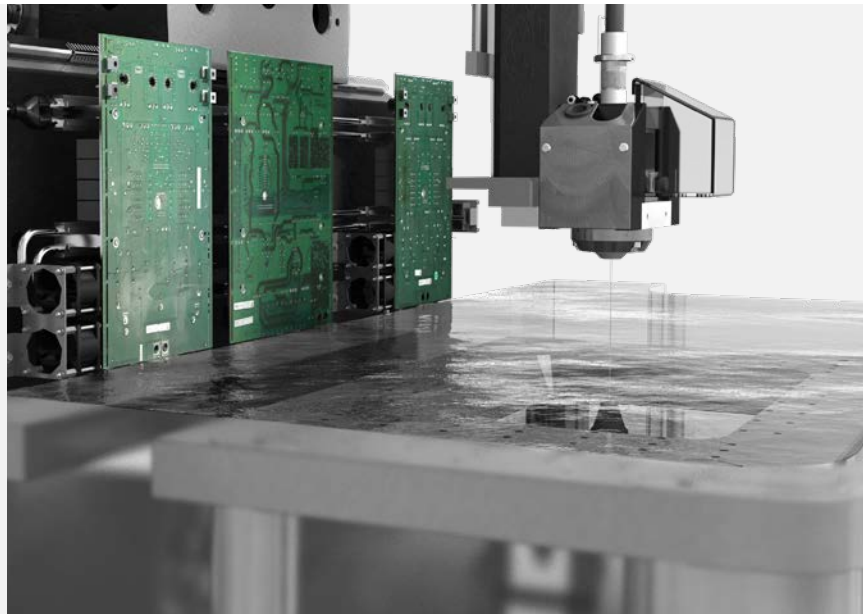

IPG main features

- Spark parameter control during all production stages, especially finishing
- Dynamic control of wire wear
- Automatic adaptation of machining parameters to the profile during roughing and skim cuts

IPG-DPS is conveniently situated close to the machine working area to accommodate shorter cable lengths and reduced impedances. By positioning the generator behind the work tank, the reduced distance between the power source and the sparking zone allows a much smaller impedance of the electrical circuit.

Less noise means better, faster and more accurate monitoring of your sparking process. In combination with the latest generation of central processing units (CPUs), the EDM process has better gap width control, better respect of geometry and surfaces, no wire breakage and very good speed.

Achieve better surface finishes by overcoming complex challenges — including poor flushing conditions, risk of wire breakage and lines on the parts.

Benefits:

Obtain the finest surface finishes and minimize polishing while maintaining geometrical accuracy.

- Ensure excellent geometrical accuracy in all parts' heights
- Gain perfect control of the fine details to ensure the highest profile accuracy



Spark control along the wire

Spark Track

To determine spark position and monitor spark concentration, Spark Track leverages the fast, accurate signal acquisition and real time data processing from modern sensor electronics. This GF Machining Solutions innovation forms the basis of outstanding features including ISPS and iWire.



Wire breakage protection

ISPS: Intelligent Spark Protection System

To make EDM cutting easier, GF Machining Solutions' Spark Track technology includes Intelligent Spark Protection System (ISPS). Its intuitive engineering evaluates the position of each discharge between the wire and the part, analyzing the concentration against a set threshold. If the concentration exceeds the threshold, ISPS automatically adjusts spark energy in real time to prevent wire breakage and maintain optimal cutting speed.

Benefits:

- Automatic real-time parameter adjustments for variable heights, blind holes, bad flushing conditions and other extremes.
- No need for an expert operator just to avoid wire breakage
- Elimination of wire breakage reduces idle time and enables automation
- Increased productivity

ISPS overcomes difficulties

- + Varying part height
- + Blind holes
- + Inclined upper or lower surfaces
- + Bad flushing conditions caused by tooling or part shape



Reduce wire consumption

iWire

iWire is an intelligent process based on Spark Track technology, which detects variations in the workpiece profile and adapts wire spool unwinding speed accordingly.

iWire optimizes wire consumption

- + monitors the spark position and concentration
- + very effective in workpieces with high variation of height
- + adapts the cutting process when upper and lower heads cannot work close to the workpiece surface
- + ideally complemented with GF SMART wire consumables

Benefits:

- Up to 40% wire consumption reduction
- Increase machine autonomy
- Reduce cost per part
- Reduce environmental impact

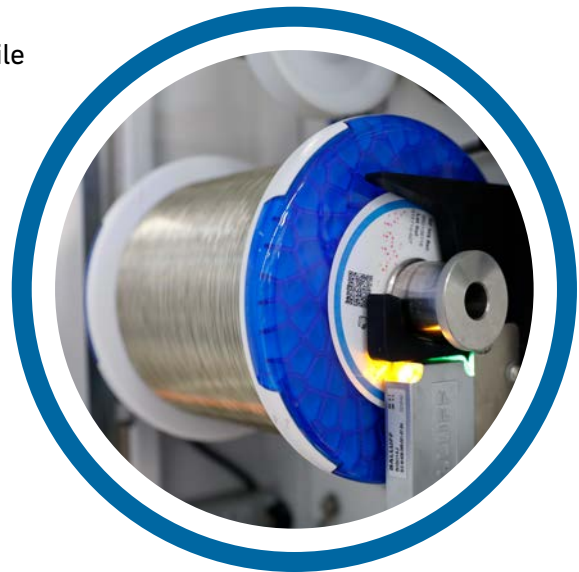

Simplify your work

Dedicated technologies

More than 600 dedicated processes to produce the best results for any need

Meet any objective with more than twice the number of dedicated processes of a standard wire EDM machine. Our CUT F series includes more than 600 technologies that cover a wide range of parts from less than 1 mm to 350 mm in height, and works with materials including steel, carbide, copper, aluminium, titanium, polycrystalline diamond (PCD) and graphite.

Whether you need quality, speed or cost, our complete wire range perfectly addresses your every need.

Benefits:

- Achieve reliable results with proven cutting parameters drawn from more than 100 years of experience
- Expand your business and the range of jobs you can accept
- With the powerful software control of UNIQUA, adopt new technologies as they emerge and when you need them

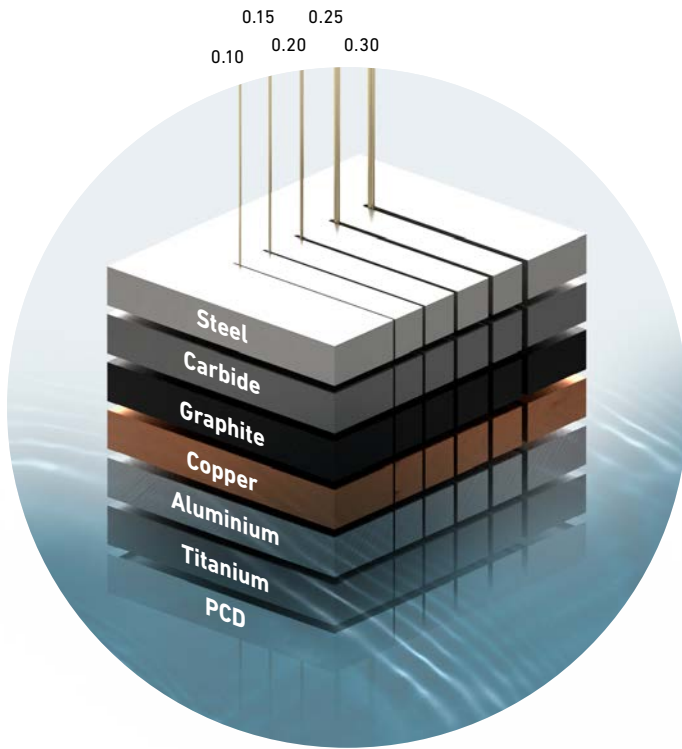

Wire diameters and materials available

For more details on wire compatibility with your application material, check the technology database.

0.1 mm



350 mm
Tall punch

Unbeatable cutting speed

Turbo Tech

Our Turbo Tech cutting technologies place an intense focus on high-speed precision, up to 40% faster than any competitor's machine with better accuracy results, depending on flushing condition and geometry. Turbo Tech is available for different wire types – AC Brass, AC Cut VS+, VH and AH – and diameters. Because Turbo Tech mainly alters trim cuts, it is fully compatible with Spark Track modules including ISPS and iWire.

Benefits:

- Increases productivity and maintains high accuracy
- Reduces costs per part
- Works with ISPS and iWire to ensure process stability and reduce wire consumption even during high-speed operations

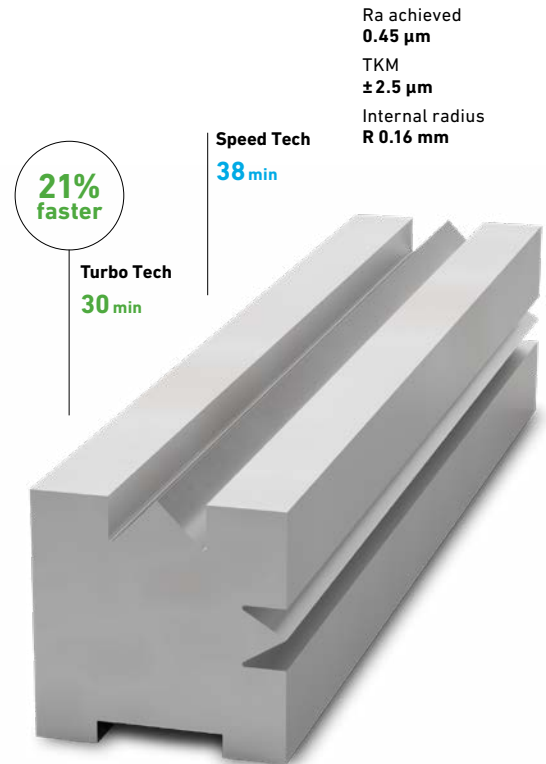

Certified wires

Choose the best wire

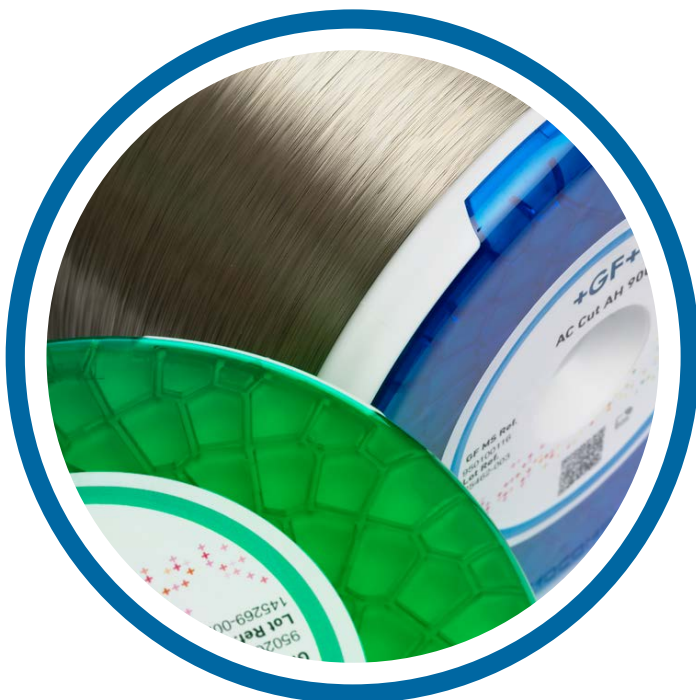

Choose your performance

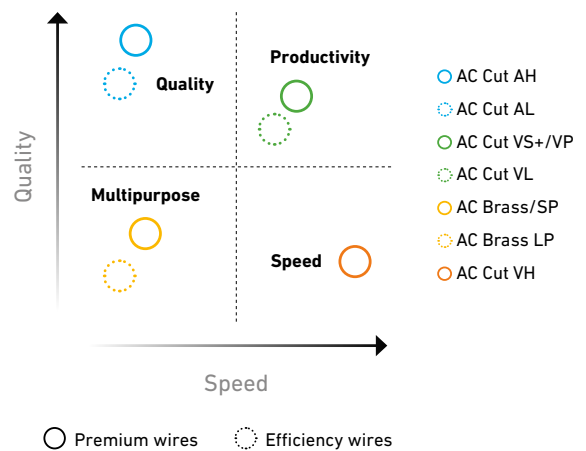

GF Machining Solutions also offers a wire range of fine and dedicated wire for specific applications: AC Cut Micro SP-Z, AC Cut Micro A, AC Cut Micro TWS, AC Cut Molybden

TAPER-EXPERT

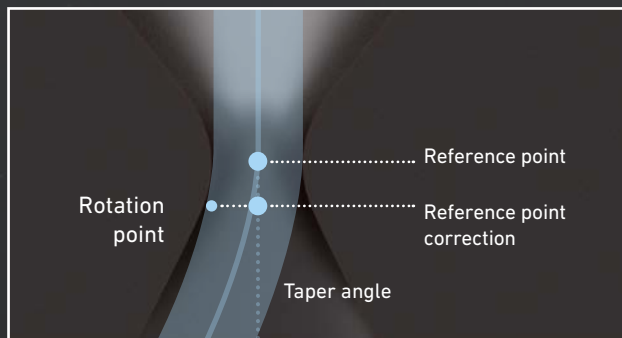

TAPER-EXPERT allows very precise machining of tapers with angles varying from 0 to 30°. It corrects in real time and during machining the position of the wire depending on the angle. The surface quality is the same as with in cylindrical machining.

Benefits:

- Unmatched taper accuracy
- Large range of applications
- Accurately-tapered surfaces increase injection mold tooling life

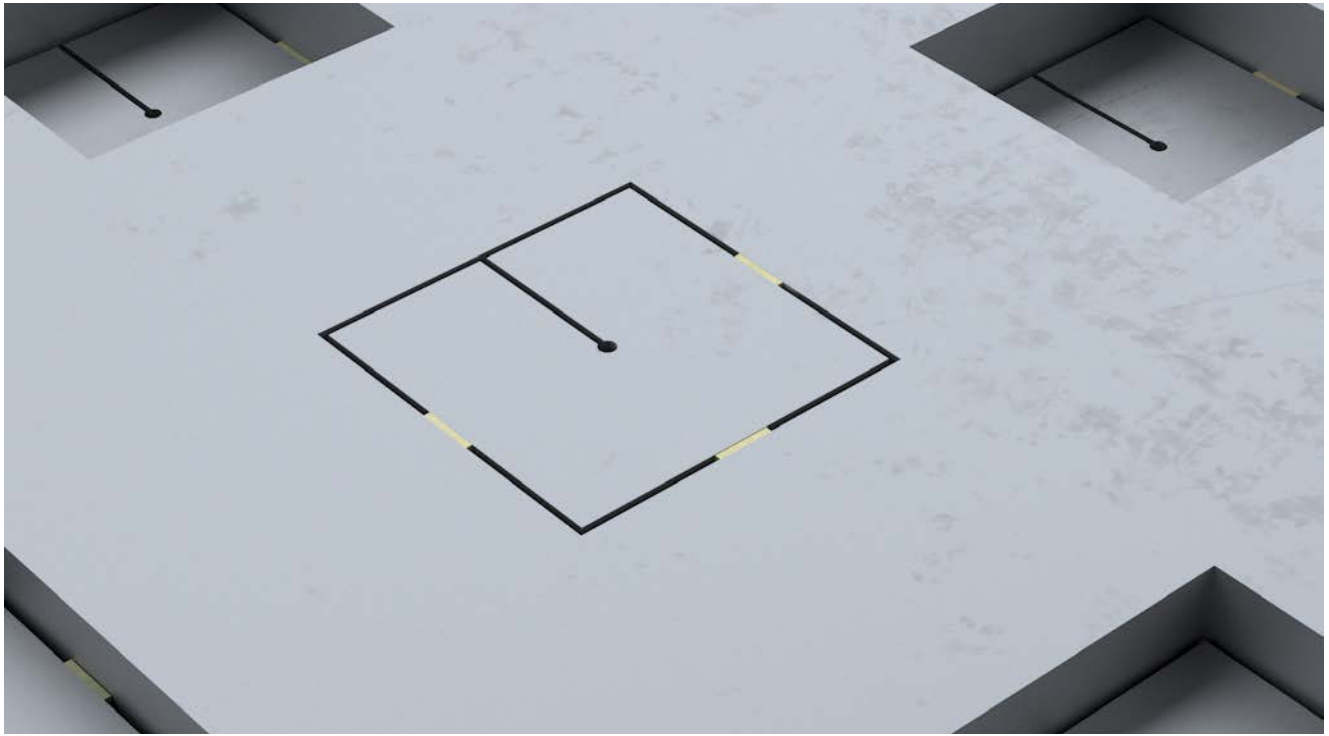

Decoupling manual intervention

ASW: Automatic Slug Welding

The new Automatic Slug Welding is an easy to configure functionality that automatically welds the core to the cavity, leaving a microfixture using a reverse erosion process. This allows you to easily remove the core by a manual tap before the finishing cuts and reduce processing time by up to 10 percent and manual intervention time by up to 90 percent.

Benefits:

- Enable 100% automation
- Faster processing time
- Reduce manual interventions
- No need for day and night strategies

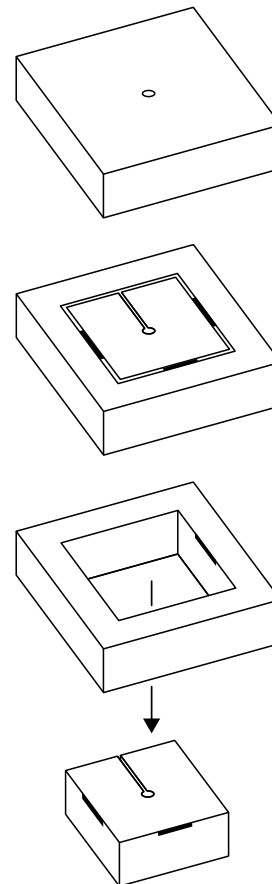

Medical instruments

High quality for medical applications

Achieve high surface quality with an Ra of 0.3 on medical instruments, thanks to the dedicated process programming of the CUT F. The distinctive shaving teeth of this stainless steel medical instrument were created with an AC Cut AH 0.25 wire. Special care was taken to ensure a radius of 0.4 mm regularly along the part.

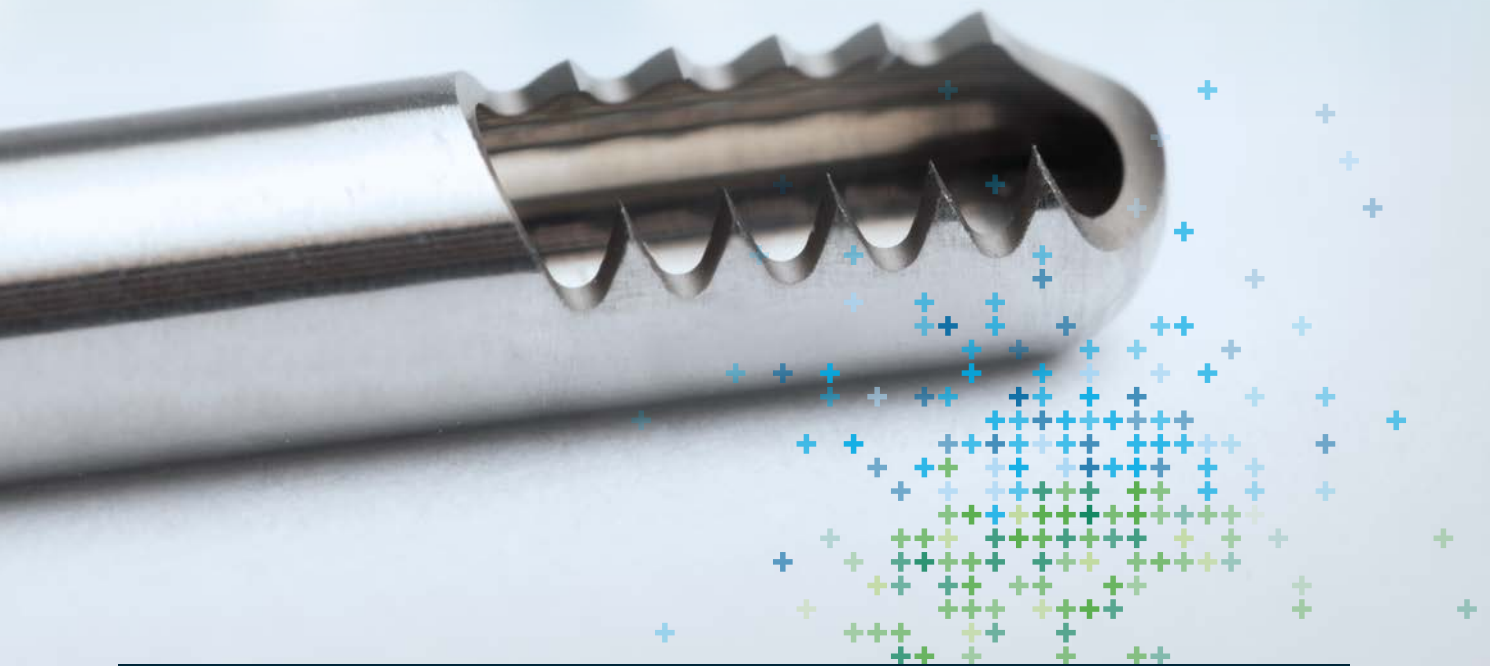

Material	Stainless steel
Wire	AC Cut AH 0.25
Cuts	4
Time	4 min 51 s
Surface	Ra 0.3 μ m

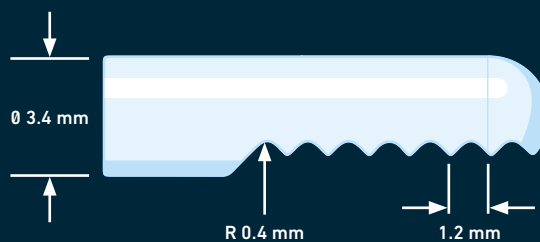

Aerospace structures

Secure challenging industrial requirements

Machining structural parts for the aerospace industry is a highly demanding process due to the high requirement standards.

Increased productivity

Thanks to the ISPS feature, no broken wire is encountered during the process, in comparison with possibly several broken wires in a conventional Wire-cutting process. Benefit from increased productivity with a reduced machining time, virtually no human interventions and minimized quantities of consumables.

Achieve low running costs

With high-volume injected or stamped parts, operating costs make a huge impact on per-part costs. Speed production with the latest, fastest process, minimized wire consumption and maximized consumables efficiency as standard features. The CUT F series reduces operating costs up to 20% over previous models.



Material	Titanium
Height	Variable
Surface	Ra 0.8 μm

	Wire broken	Operator intervention	Machining time	Total time	Machining efficiency	Wire consumption
Conventional	4	15 min	103 min	118 min	–	≈ 1600 m
ISPS + iWire	0	0 min	90 min	90 min	13%	≈ 1120 m
Saving		15 min	13 min	-24%	13%	-30%

Technical specifications

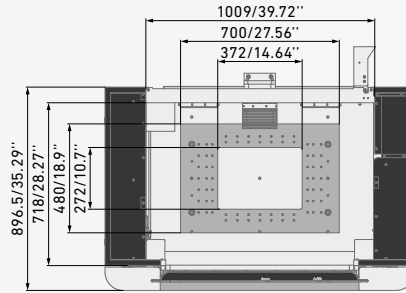
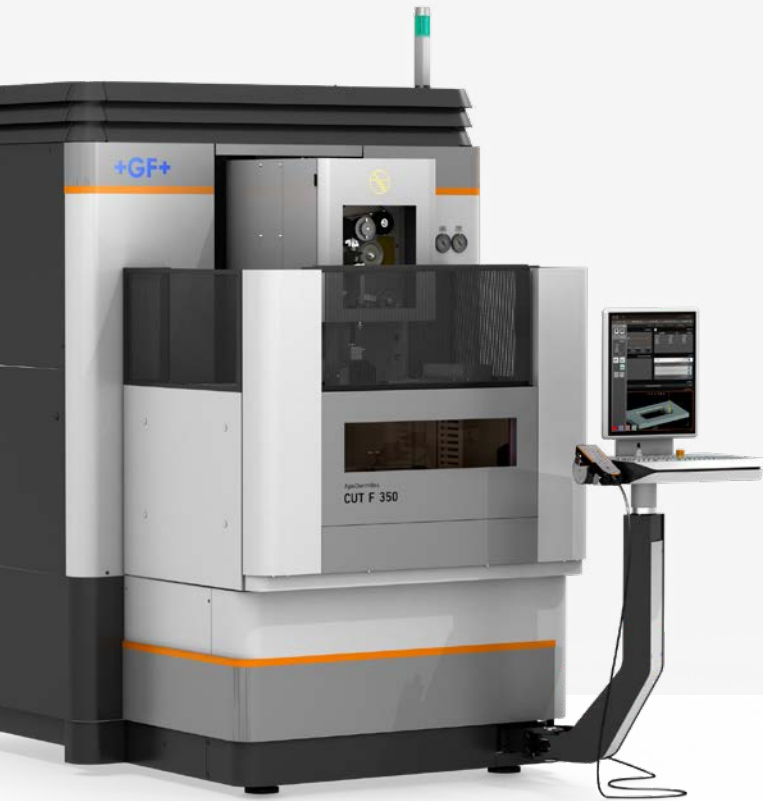

CUT F 350 table

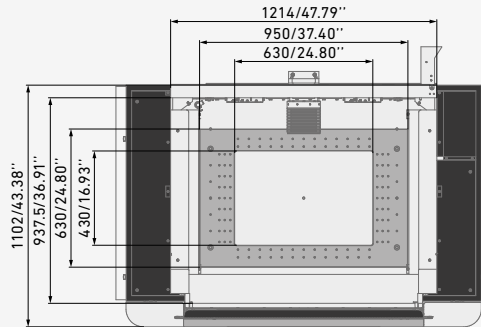

CUT F 600 table

		CUT F 350	CUT F 600
Machine			
Dimensions of complete equipment *	mm	1850 x 3050 x 2450	2160 x 3400 x 2600
	in	72.83 x 120.07 x 96.45	85.04 x 133.86 x 102.36
Total weight of equipment without dielectric	kg (lbs)	2855 (6294)	4240 (9348)
Work area			
Part dimensions	mm	820 x 680 x 250	1030 x 800 x 350
	in	32.28 x 26.77 x 9.84	40.55 x 31.5 x 13.78
Max. part weight	kg (lbs)	400 (882)	1000 (2205)
Level of dielectric min./max.	mm (in)	0/280 (0/11.02)	0/380 (0/14.96)
Air supply			
Pressure	bar	6.5-8	6.5-8
Min. flow	l/min	150 (39.6 gal/min)	150 (39.6 gal/min)
Axes			
X, Y, Z Travel	mm	350 x 250 x 250	600 x 400 x 350
	in	13.78 x 9.84 x 9.84	23.62 x 15.75 x 13.78
U, V Travel	mm (in)	± 45 (± 1.77)	± 50 (± 1.97)
Taper angle/height	°/mm (°/in)	± 30/50 (± 30/1.97)	± 30/50 (± 30/1.97)
X, Y, U, V, Z movement resolution	µm (µ-inch)	0.1 (3.94)	0.1 (3.94)
Speed of axis movement (XYZ)	m/min (in/min)	0-3 (0-118)	0-3 (0-118)
Anti-collision protection for axes		X, Y, Z	X, Y, Z
Dielectric			
Type		Deionised water	Deionised water
Total volume of dielectric	l	760 (200.77 gal)	1000 (264.17 gal)
Filtering cartridges		2	2
Deionization bottle (not standard)	l	1 (0.26 gal)	1 (0.26 gal)
Deionization resin (not standard)	l	20 (5.3 gal)	20 (5.3 gal)

* Width x depth x height

CUT F 350 / CUT F 600

Wire

Standard wire guide	mm (in)	Ø 0.20 or Ø 0.25 (Ø 0.008 or Ø 0.010)
Wire diameter (according to configuration equipment)	mm (in)	Ø 0.10-0.30 (Ø 0.004-0.012)
Automatic threading for wires	mm (in)	Ø 0.10-0.30 (Ø 0.004-0.012)
Automatic rethreading for wires	mm (in)	Ø 0.10-0.30 (Ø 0.004-0.012)
Min. diameter of pre-hole for automatic threading	mm (in)	Ø 0.80 (0.031)
Permissible weights and types of reel	kg	8 (JIS P5), 25 (DIN 160)
	lbs	17.63 (JIS P5), 55.11 (DIN 160)
Best Ra	µm (µ-inch)	0.15 (6)
Max. machine cutting speed	mm ² /min (in ² /min)	300 (0.46)

Cabinet (CUT F series)

Three-phase input voltage (V)	3 x 400
Network frequency (Hz)	50 or 60
Permissible fluctuations	±10%
Total installed power (kVA)	10
Permissible micro-break (ms)	3
Power factor	0.8
Screen/Operating system	19" / Windows
CD-ROM/Keyboard	Keyboard
Ethernet port USB	Yes
Remote control	Yes

Ambient conditions (CUT F series)

Temperature for optimum accuracy	20 ±1
Temperature for operation of the equipment	15-30
Permissible relative humidity	40-80%
Max. sound emission of the machine (Db(A))	70
Thermal stabilization time (h)	3
Level of protection of electrical equipment (IP)	43

CUT F 350

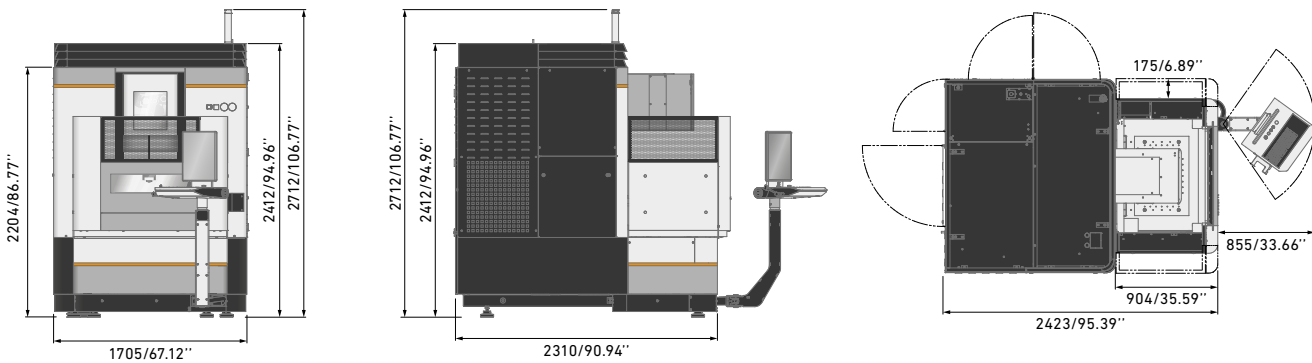

CUT F 600

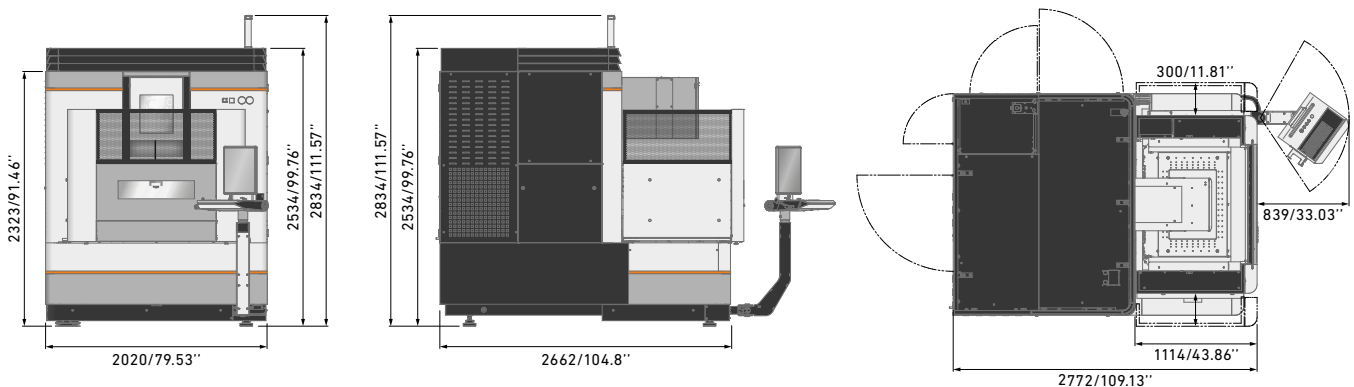

About GF Machining Solutions

Multi-technology solutions provider

Our commitment to you and your specific applications is proven by the value-adding intelligence, productivity and quality delivered by our multi-technology solutions. Your success is our chief motivator. That's why we are continuously advancing our legendary technical expertise. Wherever you are, whatever your market segment and whatever the size of your operation, we have the complete solutions and the customer-centric commitment to accelerate your success—today.

EDM (Electrical Discharge Machining)



Wire-cutting EDM

GF Machining Solutions' wire-cutting EDM is fast, precise and increasingly energy efficient. From ultraprecise machining of miniaturized components down to 0.02 mm to powerful solutions for demanding high-speed machining with respect to surface accuracy, our wire EDM solutions position you for success.

Die-sinking EDM

GF Machining Solutions is revolutionizing die-sinking EDM with features like iGAP technology to dramatically boost machining speed and reduce electrode wear. All of our die-sinking systems offer fast removal and deliver mirror finishes of Ra 0.1 µm (4 µin).

Hole-drilling EDM

GF Machining Solutions' robust hole-drilling EDM solutions enable you to drill holes in electrically conductive materials at a very high speed—and, with a five-axis configuration, at any angle on a workpiece with an inclined surface.

Tooling and Automation



Tooling

Our customers experience complete autonomy while maintaining extreme accuracy, thanks to our highly accurate System 3R reference systems for holding and positioning electrodes and work pieces. All types of machines can easily be linked, which reduces set-up times and enables a seamless transfer of workpieces between different operations.

Automation

Together with System 3R, we also provide scalable and cost-effective Automation solutions for simple, single machine cells or complex, multi-process cells, tailored to your needs.

Milling



Milling

Precision tool and mold manufacturers enjoy a competitive edge with our Mikron MILL S solutions' fast and precise machining. The Mikron MILL P machines achieve above-average productivity thanks to their high performance and Automation. Customers seeking fastest return on investment benefit from the affordable efficiency of our MILL E solutions.

High Performance Airfoil Machining

Our Liechti turnkey solutions enable the highly dynamic manufacturing of precision airfoils. Thanks to the unique performance and our expertise in airfoil machining, you increase productivity by producing at the lowest cost per part.

Spindles

As part of GF Machining Solutions, Step-Tec is engaged in the very first stage of each machining center development project. Compact design combined with excellent thermal and geometric repeatability ensure the perfect integration of this core component into the machine tool.

Software



Digitalization solutions

To drive its digital transformation, GF Machining Solutions acquired symmedia GmbH, a company specialized in software for machine connectivity. Together, we offer a complete range of Industry 4.0 solutions across all industries. The future requires the ability to adapt quickly to continual digital processes. Our intelligent manufacturing offers embedded expertise, optimized production processes, and workshop Automation: solutions for smart and connected machines.

Advanced manufacturing



Laser texturing

Aesthetic and functional texturing is easy and infinitely repeatable with our digitized Laser technology. Even complex 3D geometries, including precision parts, are textured, engraved, microstructured, marked and labeled.

Laser micromachining

GF Machining Solutions offers the industry's most complete line of Laser micromachining platforms optimized for small, high-precision features to meet the increasing need for smaller, smarter parts to support today's leading-edge products.

Laser Additive Manufacturing (AM)

GF Machining Solutions and 3D Systems, a leading global provider of additive manufacturing solutions and the pioneer of 3D printing, have partnered to introduce new metal 3D printing solutions that enable manufacturers to produce complex metal parts more efficiently.

Service + Success



We take you to new heights

Our Success Packs are designed to maximise your return on investment and empower you in your quest for success across all industrial segments. Our subscription packs feature a comprehensive range of services that guarantee the access and support you need to get the most out of your assets today, while preparing for the challenges of tomorrow. Our trusted experts backed by our latest cutting-edge, intelligent Digital Solutions, provide a full range of services.

eCatalog

Keep your equipment operating at peak precision and performance with our wide range of certified consumables and original wear parts. Our online catalog has it all (ecatalog.gfms.com).



Switzerland

Biel/Bienne
Losone
Geneva
Flawil
Langnau

www.gfms.com
www.gfms.com/ch

Europe

Germany, Schorndorf
www.gfms.com/de

United Kingdom, Coventry
www.gfms.com/uk

Italy, Agrate Brianza - MI
www.gfms.com/it

Spain, Sant Boi de Llobregat
Barcelona
www.gfms.com/es

France, Palaiseau
www.gfms.com/fr

Poland, Raszyn / Warsaw
www.gfms.com/pl

Czech Republic, Brno
www.gfms.com/cz

Hungary, Budapest
www.gfms.com/hu

Sweden, Vällingby
www.gfms.com/system3r

Americas

USA
Lincolnshire, IL
Chicago, IL
Huntersville, NC
Irvine, CA
www.gfms.com/us

Canada, Mississauga ON
www.gfms.com/us

Mexico, Monterrey NL
www.gfms.com/us

Brazil, São Paulo
www.gfms.com/br

Asia

China
Beijing, Shanghai,
Chengdu, Dongguan,
Hong Kong, Changzhou
www.gfms.com/cn

India, Bangalore
www.gfms.com/sg

Japan
Tokyo, Yokohama
www.gfms.com/jp

Korea, Seoul
www.gfms.com/kr

Malaysia, Petaling Jaya
www.gfms.com/sg

Singapore, Singapore
www.gfms.com/sg

Taiwan
Taipei, Taichung
www.gfms.com/tw

Vietnam, Hanoi
www.gfms.com/sg

At a glance

We enable our customers to run their businesses efficiently and effectively by offering innovative Milling, EDM, Laser, Additive Manufacturing, Spindle, Tooling and Automation solutions. A comprehensive package of services completes our proposition.

www.gfms.com



© GF Machining Solutions Management SA, 2023
The technical data and illustrations are not binding.
They are not warranted characteristics and are
subject to change.